

WATER MANAGEMENT

AquaCell systems

Product and installation manual

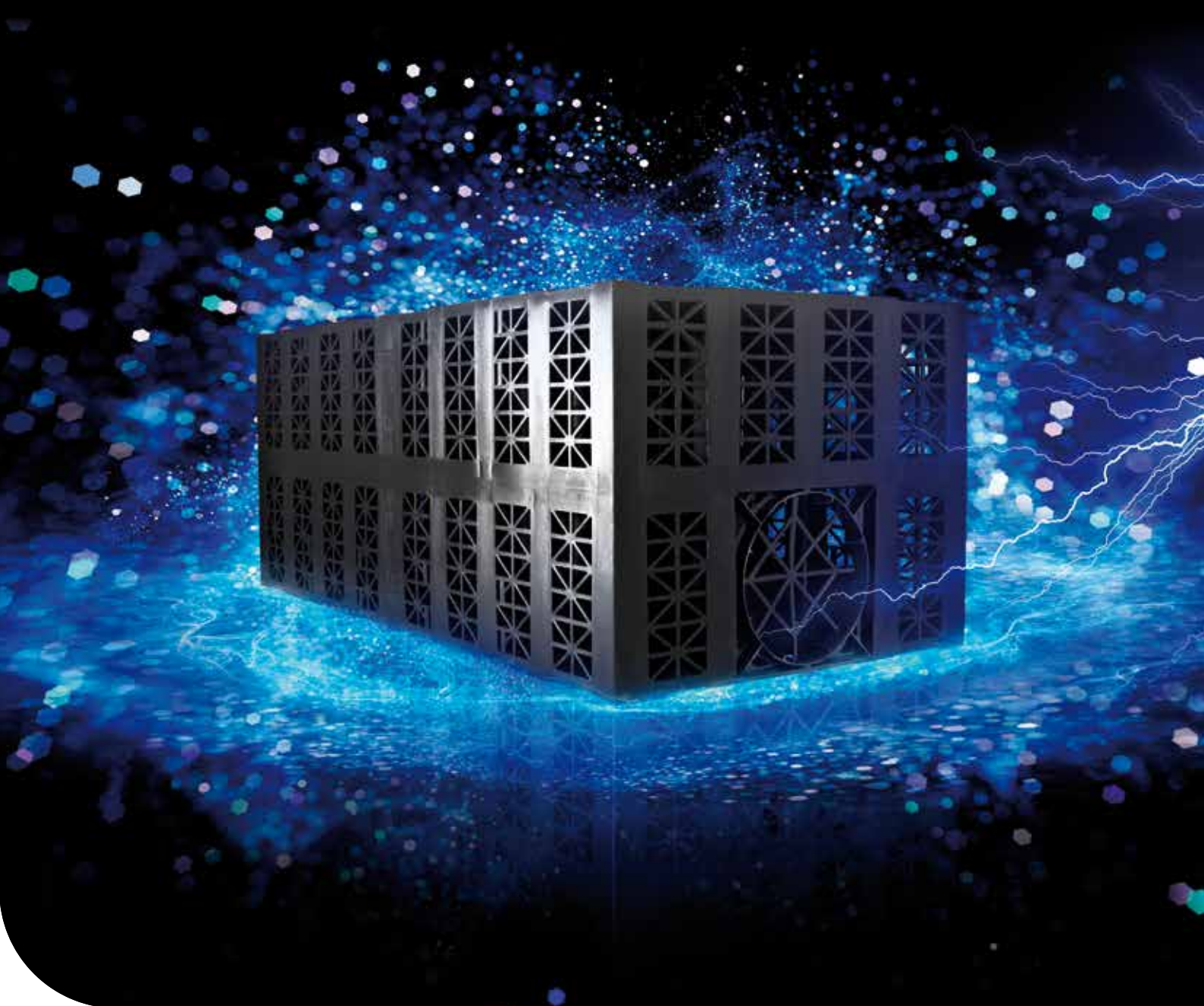

Contents

Eco

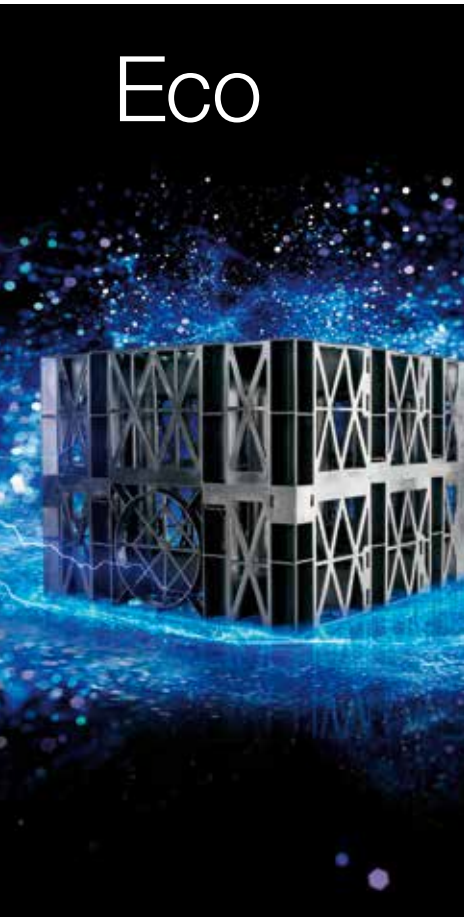

Core-R

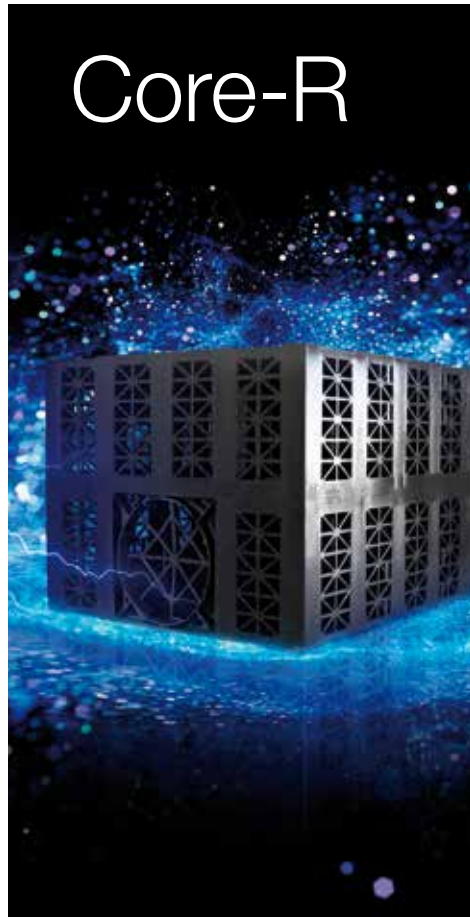

Plus-R



Introduction to SuDS	3	Installation	17	Wavin stormwater management .	32
Keeping you on top of legislation . . .	4	Typical soakaway installation	17	Supplementary items	33
Overview	5	Typical storage tank installation	18	Silt Traps	33
Product range summary	6	Silt Trap and Air Vent termination	19	Ancillaries	34-35
Product details	7	Connections	20	Spares	36
AquaCell Eco	7	Top connection for Air Vent	20	Your notes	37
AquaCell Core-R	8	Side connection for Air Vent	20		
AquaCell Plus-R	9-10	Connections to AquaCell units	21		
Design guidance	11-15	Connection configurations	22		
Installation guidance	16	Soakaway – non-traffic loading	23		
AquaCell Core-R and Plus-R:		Soakaway – traffic loading	24		
Construction loads	16	On-line storage – box feed	25		
AquaCell Eco: Construction loads . . .	16	On-line storage – manifold feed	26		
		On-line storage – central pipe feed . . .	27		
		Off-line storage – box feed	28		
		Off-line storage – manifold feed	29		
		Off-line storage – central pipe feed . . .	30		
		Soakaway or storage tank –			
		with Silt Trap	31		

Introduction to SuDS

Continuing urban development, a changing climate and the consequences of increased rainfall are all increasingly prominent issues on the political and environmental agenda and all drive the need to actively manage excessive rainfall across new and existing developments through the use of Sustainable Drainage Systems (SuDS).

Designed correctly drainage systems can assist in delivering sustainable development whilst improving the spaces where we live, work and play.

The SuDS approach to managing water takes account not just of how water quantity is managed but also considers how improvements to water quality can be delivered as well as the creation of habitats promoting biodiversity and amenity for the community.

Good SuDS aim to mimic nature and manage rainfall close to where it falls. They are designed to move and attenuate water within the development before it is released into water courses. Water is stored within the development where is allowed to infiltrate into the ground or is released at a controlled rate to prevent issues downstream.

The CIRIA SuDS Manual gives guidance on all areas of SuDS and focuses on the cost-effective planning, design, construction, operation and maintenance of SuDS.

Which SuDS components are best?

SuDS should help maximise amenity and biodiversity, whilst also delivering key objectives to manage flood risk and water quality. For any given site, SuDS should be considered as a sequence of components designed to efficiently drain surface water whilst minimising pollution.

Selection of which SuDS components is best for each development is dependent on the site specific requirements.

How can Wavin help with SuDS projects?

Wavin is well qualified to advise on how to comply with current and emerging regulation. We can aid specifiers, developers and contractors in responding to legislative demands as they pertain to flooding, sewage, urban drainage and sustainable resources use.

In particular, the proven qualities and performance of AquaCell systems not only support the achievement of SuDS, they can also help reinforce and enhance planning applications and enable development to proceed.

CIRIA SuDS Design

Source: *The SuDS Manual (CIRIA)*

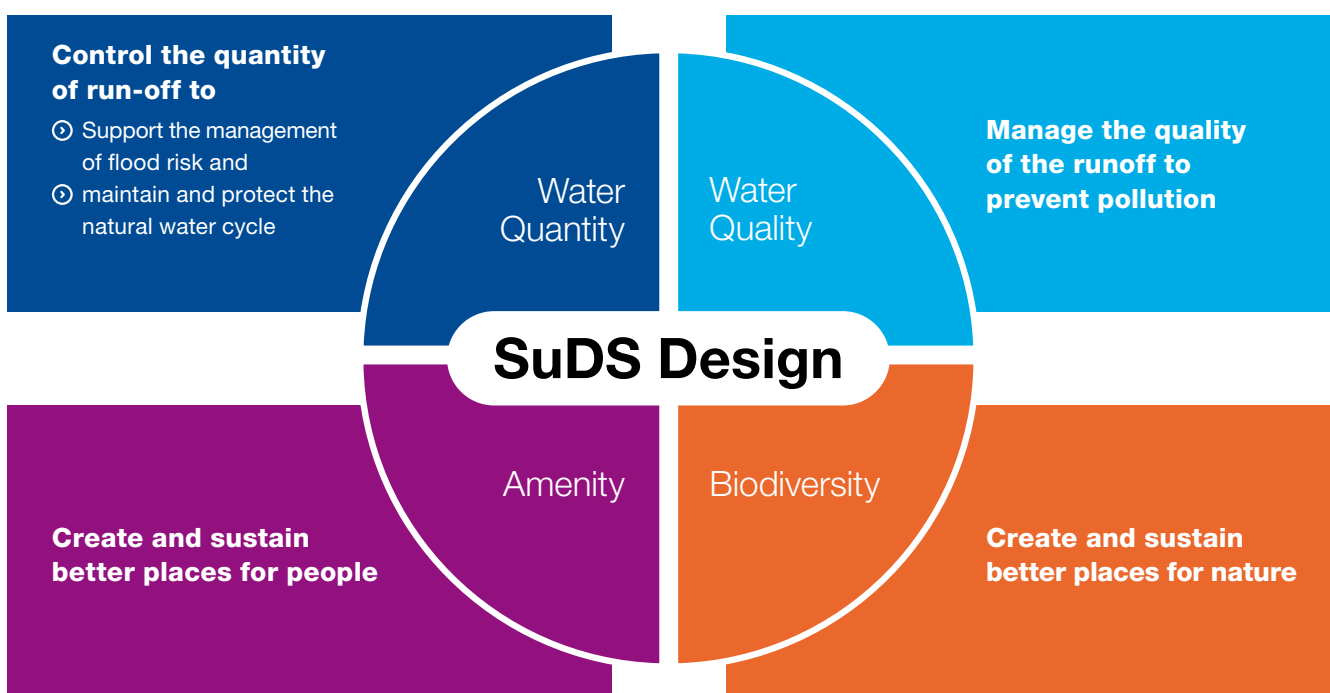

Keeping you on top of legislation

Flood and Water Management Act 2010

The Flood and Water Management Act was designed to reduce the risk of flooding and its consequences by providing for better, more comprehensive and co-ordinated water management, embracing groundwater, surface water and coastal erosion risk. Schedule 3 of the act gives DEFRA responsibility for establishing national standards for sustainable drainage and empowers local authorities to manage local flood risk by adopting and maintaining sustainable drainage schemes. In January 2019 Schedule 3 was implemented by the Welsh Government. This legislation effectively makes the use of SuDS mandatory on new developments with the aim of reducing flood risk and improving water quality. The new standards for Wales support the 'four pillars' of SuDS.

Sewers for Adoption

In England the framework for the delivery of SuDS in the absence of Schedule 3 is through a revision to Sewers for Adoption to include some SuDS components as adoptable by the Water and Sewage Companies. The document, currently with Ofwat for approval, is expected to be introduced early 2020. When it comes into force it will be the only guide to the standards that sewers must meet if they are to be adoptable by WaSCs in England. The new document will, for the first time, offer guidance on SuDS components (although not all) that can be adopted by Water and Sewerage Companies with standards on the flood risk performance that is expected.

The Water Environment and Water Services (WEWS) (Scotland) Act 2003

In Scotland WEWS makes Scottish Water responsible for SuDS that deal with the run-off from roofs and any paved ground surface within the property boundary. In order to deliver this SuDS need to be designed to Scottish Water's specifications as set out in their manual, Sewers for Scotland v4.0. In addition, the law makes the use of SuDS obligatory when dealing with surface water drainage from all new developments.

The EU Water Framework Directive

Nearly half the EU population lives in 'water-stressed' countries, caused by high extraction from freshwater sources, and demand is growing all the time. The EU Water Framework Directive introduces a new legislative approach designed to better manage and protect water resources, based not on national or political boundaries but on the natural catchment of river basins.

Building Regulation Part H (Drainage and Waste Disposal)

Building Regulation Part H embraces the guidelines for drainage and waste disposal that must be met in the UK. Although Part H extends to rainwater drainage and solid waste storage, waste drainage issues are to the fore. The Building Regulations are designed to ensure that all foul water is properly disposed of to maintain a decent level of sanitation, promoting both personal and environmental health. The regulations also highlight the importance of pollution prevention, working sewage infrastructure and sewage maintenance. With regards to stormwater, Building Regulations Approved Document H3 stipulates that adequate provision should be made for rainwater to be carried from the roof of a building to either a soakaway, water course or sewer.

National Planning Policy Framework

Section 14 of the National Planning Policy Framework sets out policy to ensure that flood risk is taken into account at all stages of the planning process and that inappropriate development in areas at risk of flooding is avoided. The policy directs development away from areas of highest risk and where new development is, exceptionally necessary in such areas, aims to make it safe without creating an increase in flood risk elsewhere and, where possible, reduce flood risk overall. It also states developments should only be allowed in an area of flood risk if it incorporates sustainable drainage systems, unless there is clear evidence that these would be inappropriate.



Overview

The AquaCell range of geocellular systems are a fully tried and tested, modular technique for managing excessive rainfall.

Applications

The AquaCell range can be used as either a temporary storage tank or as a soakaway, and is suitable for applications including:

- Ⓞ Landscaped areas
- Ⓞ Parks
- Ⓞ Domestic gardens
- Ⓞ Residential developments
- Ⓞ Car parks & roads
- Ⓞ Industrial/commercial areas



The AquaCell range

There are three types of AquaCell unit. Each can be used as a standalone system or different unit types can be mixed and matched together in layers to value engineer the most cost effective solution.

All AquaCell units have identical dimensions (1m x 0.5m x 0.4m), but they are manufactured to perform differently. The type of unit, or combination of units required will depend on factors such as the load application, overall installation depth and site conditions.

Features and benefits

The following are applicable to all AquaCell units:

- Ⓞ Modular, lightweight and versatile
 - Ⓞ Easy to handle and quick to install
 - Ⓞ Proven clip and peg connection system
 - Ⓞ 95% void (each unit holds 190 litres of water)
 - Ⓞ Can be brick-bonded for extra stability
 - Ⓞ Units can be mixed and matched together for optimum performance
 - Ⓞ Full range of ancillaries
 - Ⓞ Can be used as integral part of a SuDS scheme
- In addition, AquaCell Eco and AquaCell Core-R are fully BBA approved (Certificate No. 03/4018).

Environmental benefits

In addition, the AquaCell range can also offer the following environmental benefits:

- Ⓞ Reduced flooding risk
- Ⓞ Controlled release of stormwater into watercourses or, where permitted, existing sewer systems
- Ⓞ Recharging of local groundwater (if infiltration/soakaway application)
- Ⓞ Aerobic purification to improve water run-off quality
- Ⓞ Sustainable, cost effective management of the water environment



Eco

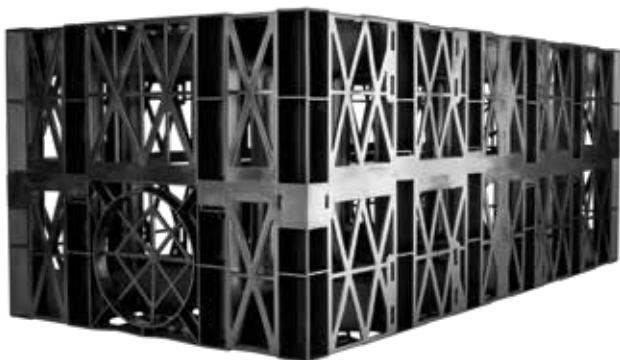

Eco is manufactured from specially reformulated, recycled material and has been designed for shallow, non-trafficked, landscape applications.

AquaCell Configurator Tool



Optimise tank and soakaway designs with the AquaCell Configurator Tool

The AquaCell Configurator tool aids and speeds the efficient design of stormwater tank or soakaway solutions. The tool guides users through a step-by-step specification process and, based on responses, will recommend the optimum design, based on the loadings, depths and site conditions of each project.

The tool generates a PDF of the design for easy download and can store the data online for future reference. To start using the tool or to learn more visit: myportal.wavin.co.uk/tools

Core-R

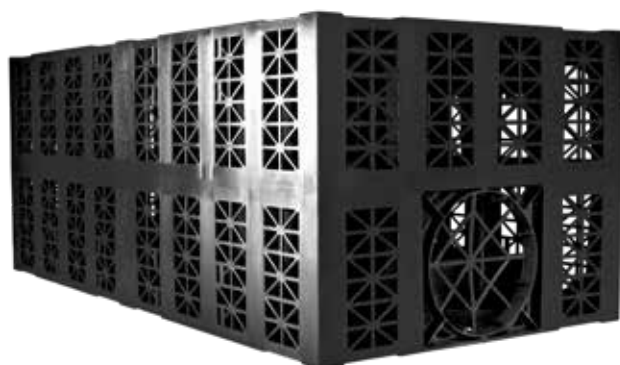

Core-R has been designed for use in deep applications, subject to both regular and heavy traffic loadings, such as cars and HGV's.

Plus-R



Plus-R has been designed primarily for use in applications where inspectability is required, and is suitable for use in all applications from landscaped areas to heavily trafficked areas including HGV.

AquaCell Eco

Application

AquaCell Eco is manufactured from specially reformulated, recycled material and has been specifically designed for shallow, non-trafficked, landscaped applications. AquaCell Eco is **NOT** suitable for locations subject to high water tables.

AquaCell Eco is typically suitable for installations to a maximum depth of 2.68 metres, to the base of the units from ground level, with a minimum cover depth of 0.3 metres, (CIRIA's recommendation, is to allow a cover depth of 0.5 metres in applications where a ride on mower may be used).

Any installation using AquaCell Eco must **NOT** be subjected to additional loading at any time. Trafficking by construction plant on site, including mechanical equipment, must be avoided.

If trafficking of the buried tank by construction plant or, other vehicles is unavoidable, the installation should be constructed using AquaCell Core-R units (see page 9).

The width of an AquaCell Eco installation should not exceed 12 metres to allow for mechanical backfilling without loading. There is no limit to the length of the installation.

Features and benefits

- ⦿ Manufactured from specially reformulated, recycled material
- ⦿ Suitable for both soakaway and attenuation applications
- ⦿ Proven vertical loading capacity of: 21.3 tonnes/m² (213kN/m²)
- ⦿ Proven lateral loading capacity of: 5.2 tonnes/m² (52kN/m²)
- ⦿ Integral "hand holds" for ease of carrying/handling
- ⦿ BBA approved – Certificate No 03/4018

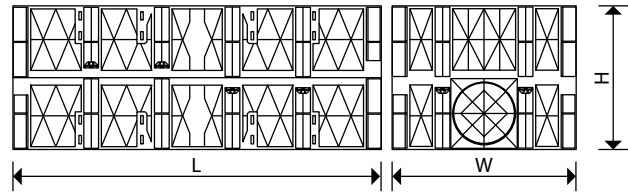
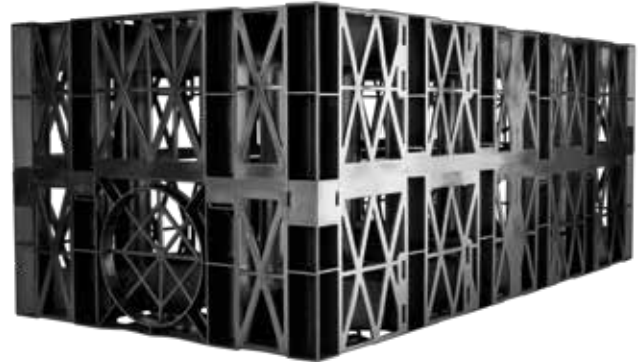

Material: Reformulated polypropylene

Nominal size (mm)	Part number	Dimensions (mm)		
		W	H	L
160	6LB025	500	400	1000

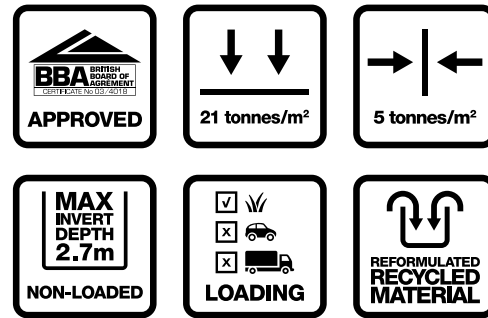

Maximum installation depths – to base of units (m)¹

Typical soil type	Soil weight kN/m ³	Angle of internal friction ϕ (degrees) ^{2, 3}	Landscaped areas
Over-consolidated stiff clay	20	24	1.53
Silty sandy clay	19	26	1.68
Loose sand and gravel	18	30	2.08
Medium dense sand and gravel	19	34	2.35
Dense sand and gravel	20	38	2.68

(1) These values relate to installations where the groundwater is a minimum of one metre below the base of the excavation.

(2) AquaCell Eco units should not be used where groundwater is present.

(3) 0.5m cover is required where a ride-on mower may be used.

Assumptions made: ⦿ Ground surface is horizontal
 ⦿ Shear planes or other weaknesses are not present within the structure of the soil.

AquaCell Core-R

Application

AquaCell Core-R has been designed for use in deep applications, subject to regular and heavy traffic loadings, e.g. cars and HGV's. AquaCell Core-R can also be used for deep soakaways and landscaped applications.

Typically for use down to depths of 6.24m in landscaped areas (5.99m trafficked by cars) to the base of the units from ground level, in best soil conditions.

Trafficking by heavy construction plant on site, including mechanical equipment, must be avoided until the minimum cover depth of 1.21 metres is in place.

Features and benefits

- ⌚ Suitable for regular and heavy traffic loadings
- ⌚ Proven vertical loading capacity of: 65 tonnes/m² (650 kN/m²)
- ⌚ Proven lateral loading capacity of: 11 tonnes/m² (110kN/m²)
- ⌚ BBA approved – Certificate No 03/4018
- ⌚ Ideal for all types of shallow and deep projects including major attenuation and infiltration schemes

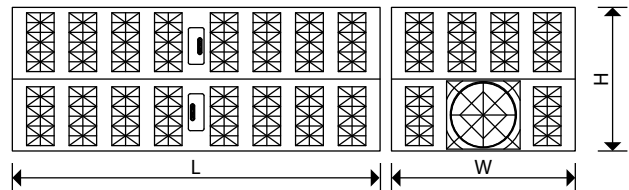
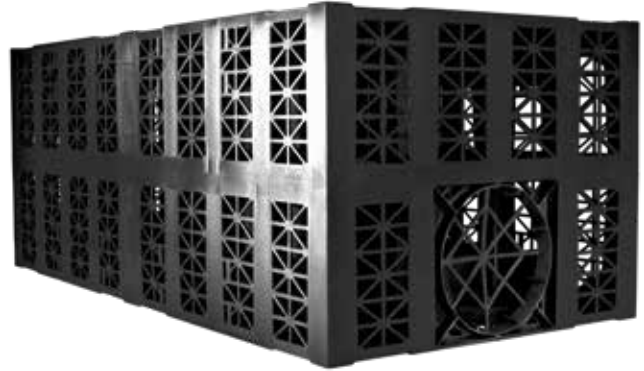

Nominal size (mm)	Part number	Dimensions (mm)		
		W	H	L
160	6LB150	500	400	1000

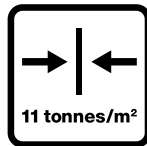
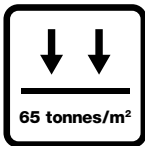

Maximum installation depths – to base of units (m)¹

Typical soil type	Soil weight kN/m ³	Angle of internal friction ϕ (degrees) ^{2,3}	Landscaped areas	Vehicle mass <9 tonnes ^{4,5}	Vehicle mass <44 tonnes
Over-consolidated stiff clay	20	24	3.60	3.35	3.10
Silty sandy clay	19	26	4.07	3.81	3.54
Loose sand and gravel	18	30	4.99	4.71	4.43
Medium dense sand and gravel	19	34	5.55	5.28	5.02
Dense sand and gravel	20	38	6.24	5.99	5.74

- (1) Without groundwater present below base of units – AquaCell Core-R may be used where groundwater is present, contact Wavin for technical advice.
- (2) Loosening of dense sand or softening of clay by water can occur during installation. The designer should allow for any such likely effects when choosing an appropriate value of ϕ .
- (3) The design is very sensitive to small changes in the assumed value of ϕ , therefore, it should be confirmed by a chartered geotechnical engineer. In clay soils, it may be possible to utilise cohesion in some cases.
- (4) Applicable for car parks or other areas trafficked only by cars or occasional refuse collection trucks or similar vehicles (typically one per week).
- (5) This category should be used when considering landscaped areas that may be trafficked by ride on mowers.

Assumptions made: ⌚ Ground surface is horizontal

⌚ Shear planes or other weaknesses are not present within the structure of the soil.

AquaCell Plus-R

Application

AquaCell Plus-R has been designed primarily for use in applications where inspection is required. It is suitable for use in all applications from landscaped areas to heavily trafficked areas (for vehicles up to 44 tonnes). The units can be used in combination with AquaCell Core-R (and Eco if there is at least one layer of Core-R in between the Plus-R and Eco layer).

Extra lateral loading capacity allows installation at greater depths. Integral inspection channels in each unit combine to create viewing channels for the full length of the installed structure.

Typically for use down to depths of 7.82m in landscaped areas (7.57m trafficked by cars and 7.3m trafficked by HGV's) to the base of the units from ground level, in best soil conditions. Trafficking by heavy construction plant on site, including mechanical equipment, must be avoided until the minimum cover depth of 1.30 metres is in place.

Features and benefits

- ⦿ Suitable for extra deep installations
- ⦿ Inspectable (supplied with end cap for use when an inspection channel is not required)
- ⦿ Proven vertical loading capacity of: 70.2 tonnes/m² (702 kN/m²)
- ⦿ Proven lateral loading capacity of: 15.1 tonnes/m² (151 kN/m²)

Maximum installation depths – to base of units (m)¹

Typical soil type	Soil weight kN/m ³	Angle of internal friction ϕ (degrees) ^{2,3}	Landscaped areas	Vehicle mass <9 tonnes ^{4,5}	Vehicle mass <44 tonnes
Over-consolidated stiff clay	20	24	4.67	4.42	4.17
Silty sandy clay	19	26	5.03	4.78	4.53
Loose sand and gravel	18	30	5.86	5.61	5.36
Medium dense sand and gravel	19	34	6.87	6.62	6.37
Dense sand and gravel	20	38	7.82	7.57	7.30

- (1) Without groundwater present below base of units – AquaCell Plus-R may be used where groundwater is present, contact Wavin for technical advice.
- (2) Loosening of dense sand or softening of clay by water can occur during installation. The designer should allow for any such likely effects when choosing an appropriate value of ϕ .
- (3) The design is very sensitive to small changes in the assumed value of ϕ , therefore, it should be confirmed by a chartered geotechnical engineer. In clay soils, it may be possible to utilise cohesion in some cases.
- (4) Applicable for car parks or other areas trafficked only by cars or occasional refuse collection trucks or similar vehicles (typically one per week).
- (5) This category should be used when considering landscaped areas that may be trafficked by ride on mowers.

Assumptions made: ⦿ Ground surface is horizontal
 ⦿ Shear planes or other weaknesses are not present within the structure of the soil.

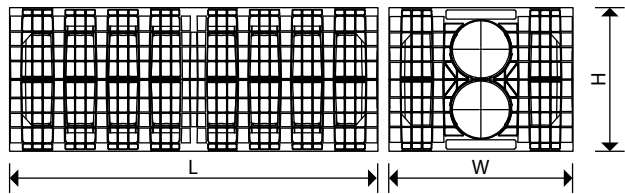
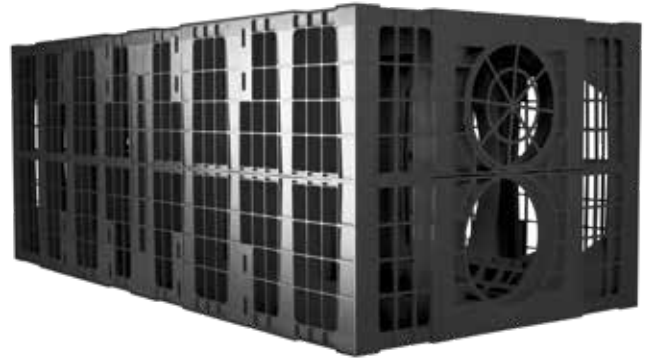

Material: Polypropylene

Nominal size (mm)	Part number	Dimensions (mm)		
		W	H	L
160	6LB200	500	400	1000

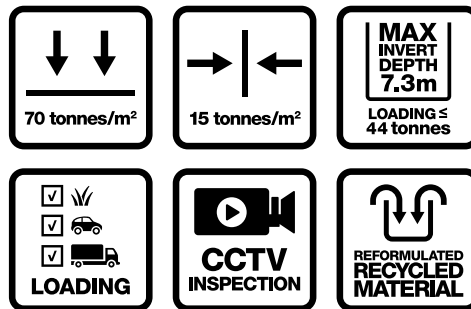

AquaCell Plus-R: for inspectability

By aligning AquaCell Plus-R units end-to-end, full length viewing channels can be created – allowing for CCTV inspection if required. These are created in the bottom layer of an AquaCell tank installation.

The units can be used in combination with AquaCell Core-R (and with Eco if there is at least one layer of AquaCell Core-R in between the Plus-R and Eco layer).

NOTE: For any AquaCell Plus-R units on the perimeter of a structure that are NOT required for inspection access, the open ends of the integral inspection tunnels should be fitted with the end caps provided.

Inspection chambers

An inspection chamber should precede the inlet pipework for the AquaCell structure.

A silt trap or hydro-dynamic separator prior to the inspection chamber is also recommended.

For on-line installations the following Chambers are recommended:

- Down to 3m Wavin Non-Entry Inspection Chambers
- Down to 5m Wavin Range 600 Inspection Chambers, or a traditional manhole*

**where inlet pipework is replaced by AquaCell units acting as flow conduit.*

For off-line installations:

- Manhole with in-built flow control

Recommendation: If installing any Wavin Non-Entry Inspection Chamber, deeper than 1.2 metres, ensure that the cover and frame includes a 350mm restrictor to prevent man entry.

Inspection and maintenance

CCTV inspection at every inspection point is recommended:

- after every major storm
- at regular intervals according to the specific maintenance plan for the site

Silt traps prior to inlet pipework should be routinely inspected and cleaned out to minimise debris reaching the tank. It is important to prevent construction silt from entering the AquaCell structure.

Inspectability scenarios

AquaCell Plus-R viewing channel



Trafficked tank installation with inspection chambers

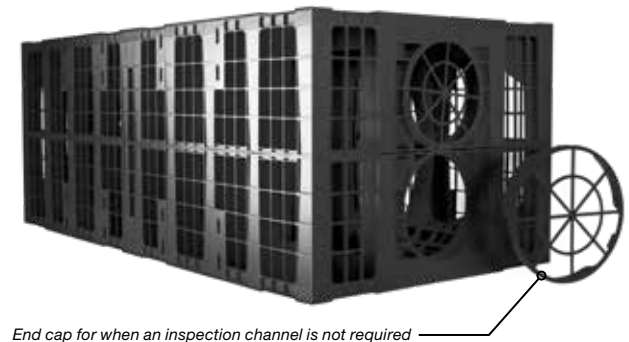
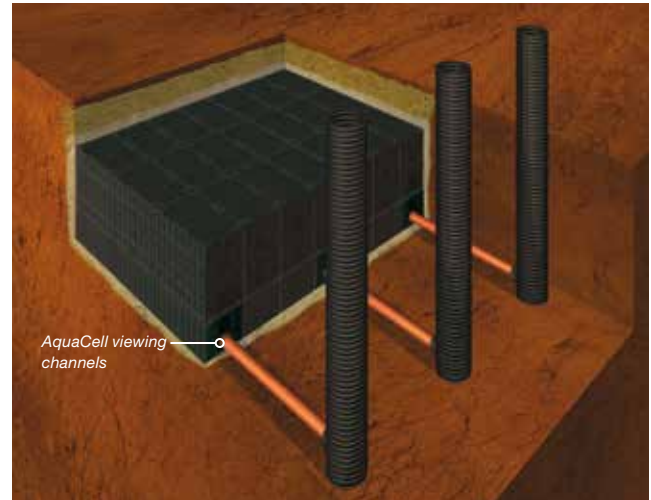

Design guidance

Infiltration or attenuation?

The AquaCell range can be used either as:

- ⦿ A soakaway whereby the units will be installed in suitable pervious soils so the units can be wrapped in a geotextile to allow infiltration of the stormwater into the surrounding ground, or
- ⦿ As an attenuation tank in impervious ground (e.g. clay) where infiltration is not possible, here the units are encapsulated in a geomembrane (which is in turn wrapped in a protective geotextile layer) so that the structure can hold the stormwater temporarily until local drainage flows can accept it for normal disposal at a permissible outflow rate.

Large scale AquaCell Core-R storage tank



Domestic AquaCell Core-R soakaway



Site assessment

Ground conditions may be established as part of a geotechnical assessment. This may include tests for infiltration and ground water level.

If there is no confirmation that such assessments have been conducted, or resulting conclusions are unavailable, a trial pit will be required in accordance with BRE 365.

For further information and guidance, please contact the Wavin Technical Design Team.

Infiltration (soakaways)

According to the principals of SuDS, wherever possible stormwater should be drained back into the ground via a soakaway as the first priority. A site must meet BOTH of the following criteria for infiltration to be possible:

- ⦿ The underlying soil surrounding the proposed installation is sufficiently permeable
- ⦿ The seasonally high water table is a minimum of 1 metre below the base of the proposed installation

If either of these criteria is not met, or cannot be confirmed for any reason, a soakaway system may not be suitable for the application, in which case a storage tank must be used.

Attenuation (storage tanks)

A storage tank may be designed to be online or offline (see pages 26-31 for typical details). However, if the site is subject to groundwater or a high water table, it is important to ensure that the tank is not vulnerable to flotation. Sufficient weight from soil, or other covering placed over the AquaCell units, must be sufficient to counter any buoyancy uplift force from the rising groundwater level.

Important design considerations for geocellular structures

Rising rainfall levels and increased focus on SuDS compliance, have led to an increase in the use of modular units to create underground structures for infiltration or the temporary storage of stormwater.

However, not all currently available systems have the proven performance characteristics necessary to meet the wide range of complex underground geocellular applications.

The Wavin range of AquaCell units provide assured performance, since all strength and hydraulic capabilities have been verified by independent testing and our ECO and CORE-R units are both BBA approved.

To guarantee the structural integrity of an engineered drainage system, any underground structure must be strong enough to support the loads to which it will be subjected without any unacceptable deflection.

The correct choice of geocellular unit must have appropriate proven top (vertical) and side (lateral) load bearing capacity and deflection characteristics to suit site conditions.

The five key site considerations to be noted when designing a geocellular structure are:

1. Depth of cover (See page 14)
2. Soil type
3. Surface finishing
4. Presence of groundwater
5. Type of traffic/loading

A: Non-trafficked

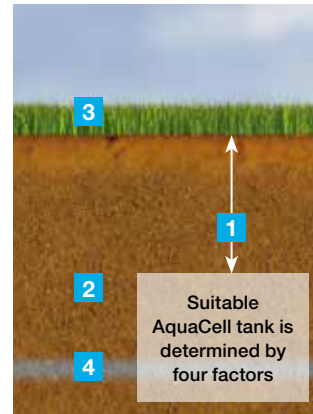

B: Trafficked

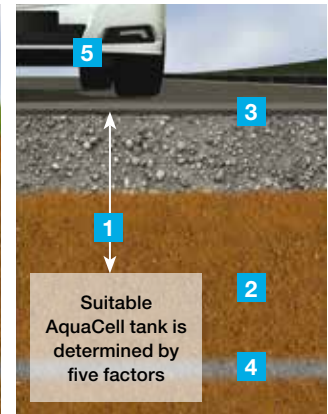

The combination of these 5 factors effectively means that the required characteristics of a geocellular structure to be installed under a trafficked location (for example) will be very different from that under a landscaped/low-loaded location.

Two typical examples are given below.

Example A: Landscaped/non-trafficked location and 0.3m cover depth. Typically requires minimum vertical strength of 17.5 tonnes/m²

Example B: Car park with occasional light delivery traffic and between 0.5 – 0.7m cover depth. Typically requires minimum vertical strength of 40 tonnes/m²

Design guidance

Hydraulic design

All AquaCell units have identical dimensions: 1m x 0.4m x 0.5m, have a nominal void ratio of 95% and each holds 190 litres of water. Hydraulic calculations are accordingly the same for AquaCell Eco, Core-R and Plus-R.

Structural design however, requires careful consideration of loading factors specific to each location – see CIRIA C680 or CIRIA C737 for further guidance (we recommend using the BPF Guide Designing Geocellular Drainage Systems to CIRIA Report C737 alongside.)

Structural design – installation and cover depths

Each AquaCell unit has been designed to have specific loading capacities (see pages 8-10) that define the maximum depth parameters for which they are suitable.

Minimum depth of cover varies according to whether or not the installation will be subject to trafficking by cars/HGVs.

However, in some situations, installations may have to be located with greater cover depths. Reasons may include:

- ④ Deep-running drainage network
- ④ Other buried services running above tank location
- ④ Installation into banked/ sloping ground
- ④ Upper layer of clay preventing infiltration

The table shows a summary of typical cover depths and installation depths as a guide.

Typical minimum cover depths and maximum installation depths

Location type	Minimum cover depths (m)		
	AquaCell Eco	AquaCell Core-R	AquaCell Plus-R
Landscaped/non-trafficked areas ²	0.30	0.30	0.30
Car parks, vehicle mass up to 9 tonnes ¹	n/a	0.64	0.69
HA/HGV loading up to 60 tonnes	n/a	1.21	1.30
	Maximum installation depths (m) ³		
Maximum depth to base of unit (Landscaped)	2.68	6.24	7.82
Maximum depth to base of unit – vehicle mass up to 9 tonnes	n/a	5.99	7.57
Maximum depth to base of unit – vehicle mass up to 44 tonnes	n/a	5.74	7.30

- (1) For specific advice on cover depths for heavier loadings/HGV applications, contact Wavin Technical Design on 0844 856 5165.
- (2) 0.30m is minimum depth for AquaCell in landscaped applications. 0.5m cover is recommended in applications where ride-on mowers may be used. If construction plant is to be used on site, extra protection may be needed.
- (3) Allowable maximum depth to base of bottom layer of units is dependent on soil type, angle of shearing resistance, loadings, and groundwater level. The above depths are based on 38° angle of shearing resistance and no groundwater.

In trafficked applications it is recommended that the height of any tank should not exceed 2m (5 units). If you require a tank that exceeds this, please contact Wavin Technical Design for guidance:

T: 0800 038 0088 E: technical.design@wavin.co.uk

Minimum cover and maximum installation depths to base of units from ground level, in best soil conditions

This chart shows how deep each unit can be used for different applications in best soil conditions.

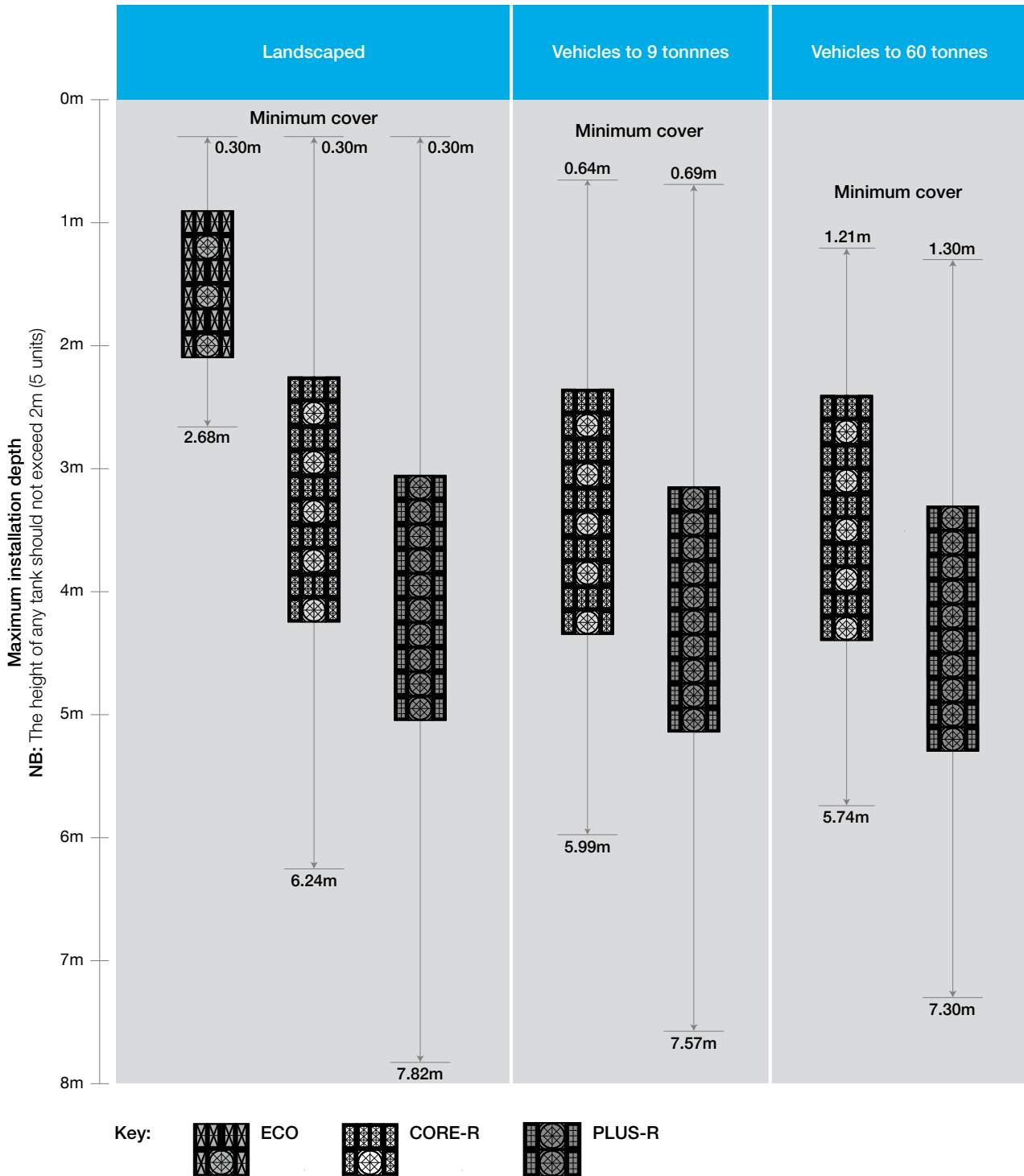

Note: The AquaCell units can also be used in combination with each other, please contact Wavin Technical Design for guidance.

Design guidance

Mix and match

Although all AquaCell units have identical dimensions, and a high nominal void ratio of 95%, they are manufactured to perform at a range of depths, dependent on soil type, angle of shearing resistance, loading and ground water levels. For optimum performance the units can be mixed and matched (in layers) to value engineer the most effective design (in cost and performance terms) for each installation. For example, in a landscaped application if you needed to install a tank or soakaway that is deeper than 2.7m, you could install layers of AquaCell Core-R underneath the AquaCell Eco. See below illustrations showing examples of how the AquaCell units can be mix and matched together. For advice on how to optimise a tank or soakaway design using more than one type of AquaCell please contact Wavin Technical Design.

Note: AquaCell Eco cannot be used directly with AquaCell Plus-R therefore there must be a layer of AquaCell Core-R between them.

Typical examples of mix and match with AquaCell

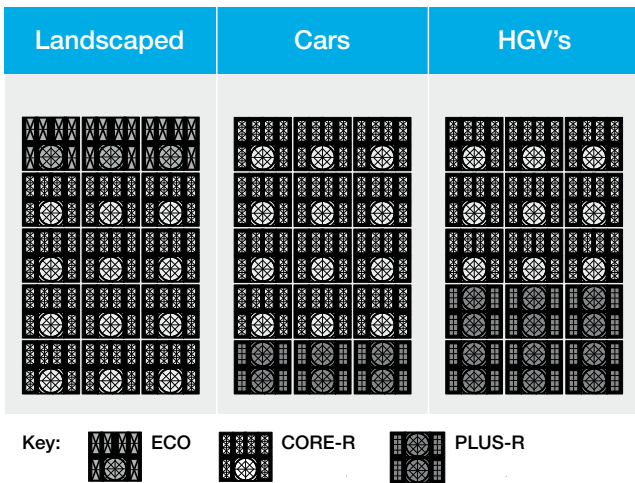

Brick bonding – for extra stability

When assembling a geocellular structure that comprises two or more layers, it is recommended that AquaCell units are placed in a 'brick-bonded' configuration for extra stability.

This helps minimise continuous vertical joints in the assembly, and gives the structure extra stability.

A significant advantage of AquaCell unit design is that brick bonding placement does not require extra connectors.

All three AquaCell units may be placed in this way, unless inspection channels and cleaning access are required using AquaCell Plus-R.

AquaCell Plus-R units incorporate integral inspection channels. These are designed for combined alignment to create viewing tunnels at the base of an assembled structure (see page 11).

Example of AquaCell being brick bonded

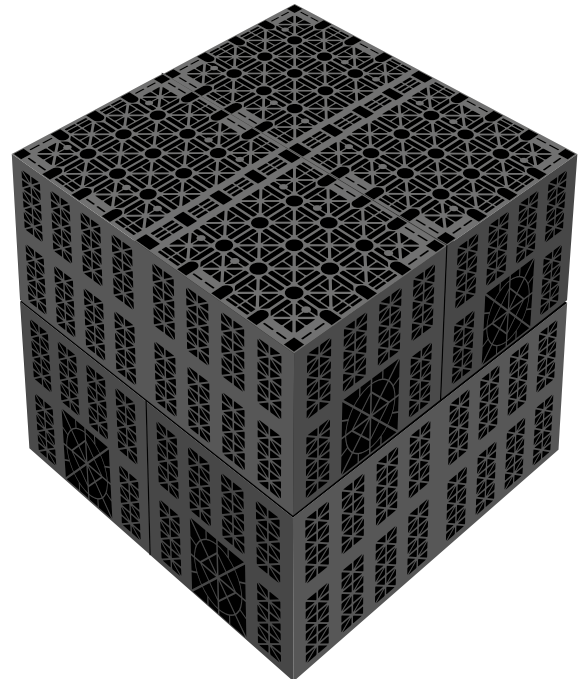

Installation guidance

AquaCell Core-R and Plus-R: Construction loads

Construction plant such as excavators can impose significant loads on any AquaCell unit. The following guidelines should be observed:

- ① Tracked excavators (not exceeding 21 tonnes weight) should be used to place fill over the AquaCell units when the geotextile or geomembrane wrapping has been completed
- ① At least 300mm of fill should be placed before the excavators or trucks delivering the backfill are allowed to traffic over the installed units
- ① Compaction plant used over the AquaCell units should not exceed 2300kg/metre width. This will allow the compaction of Type 1 sub-base in 150mm layers over the units in accordance with the Specification for Highways Works
- ① All other construction plant should be prevented from trafficking over the system once it is installed and surfacing completed, unless a site specific assessment demonstrates that it is acceptable
- ① In particular cranes should not be used over, or place their outriggers over the system

AquaCell Eco: Construction loads

As AquaCell Eco is designed for landscaped and non-loaded applications, certain precautions are recommended on site to prevent damage to the units through excess loading.

Manual assembly

Whilst assembling the tank, it may be necessary to walk on top of previously laid AquaCell units. Therefore care should be taken not to damage the edges of the units.

Backfilling

When backfilling AquaCell Eco installations:

- ① Machines placing the material must be located OFF the units
- ① Only light compaction should be applied to the material
- ① Backfill with suitable, stone-free, as-dug material
- ① First layer should be 300mm thick before using any compaction plant
- ① NO vibratory mechanism should be used for compacting this first layer
- ① Compaction plant must not exceed 2300kg per metre width

Construction traffic on site

Once backfilled, if construction plant (e.g. excavators or loaders) are likely to run over the installation, ensure that:

- ① MINIMUM protective cover should be 500mm well-compacted granular material
- ① Only tracked excavators can be used and MUST NOT weigh more than 14 tonnes.
- ① HGVs MUST NOT run over installed AquaCell Eco units

Manual assembly

All ancillaries and adaptors (see pages 34-37) can be used with either the AquaCell Eco, Core-R or Plus-R units, except the 225mm Flange Adaptor (6LB106) which must only be used with AquaCell Core-R or Plus-R.

The 150mm Flange Adaptor (6LB104) should only be used when constructing an air vent on the top surface of an AquaCell Eco unit. The adaptor should not be used to connect inlet pipes to the side of an Eco unit.

Installation

Typical soakaway installation method

Typical installation procedure

1. Excavate the trench to the required depth ensuring that the plan area is slightly greater than that of the AquaCell units.
2. Lay 100mm bed of coarse sand or non angular granular material, level and compact.
3. Lay the geotextile* over the base and up the sides of the trench.
4. Lay the AquaCell units parallel with each other. In multiple layer applications, wherever possible, continuous vertical joints should be avoided. AquaCell units can be laid in a 'brick bonded' formation (i.e. to overlap the joints below) – see page 16. For single layer applications use the AquaCell Clips and for multi layers use the AquaCell Clips and the AquaCell Shear Connectors (vertical rods).
5. Fix the Adaptors to the AquaCell units as required and connect pipework.
6. In order to prevent silt from entering the tank, clogging inlet pipework and reducing storage capacity, it is recommended that the Domestic Silt Trap (6LB300) or one of the standard Silt Traps (6LB600, 6LB625, 6LB630) is installed prior to the inlet pipework – see page 24 for installation guidelines.
7. Wrap and overlap the geotextile covering the entire AquaCell structure.
8. Lay 100mm of coarse sand or non angular granular material between the trench walls and the AquaCell structure and compact.
9. Lay 100mm of coarse sand or non angular granular material over the geotextile and compact.
10. Backfill with suitable material.
11. Rainwater from roof areas may discharge directly into the soakaway but rainwater from carparks must discharge through a catchpit manhole and/or a petrol interceptor.

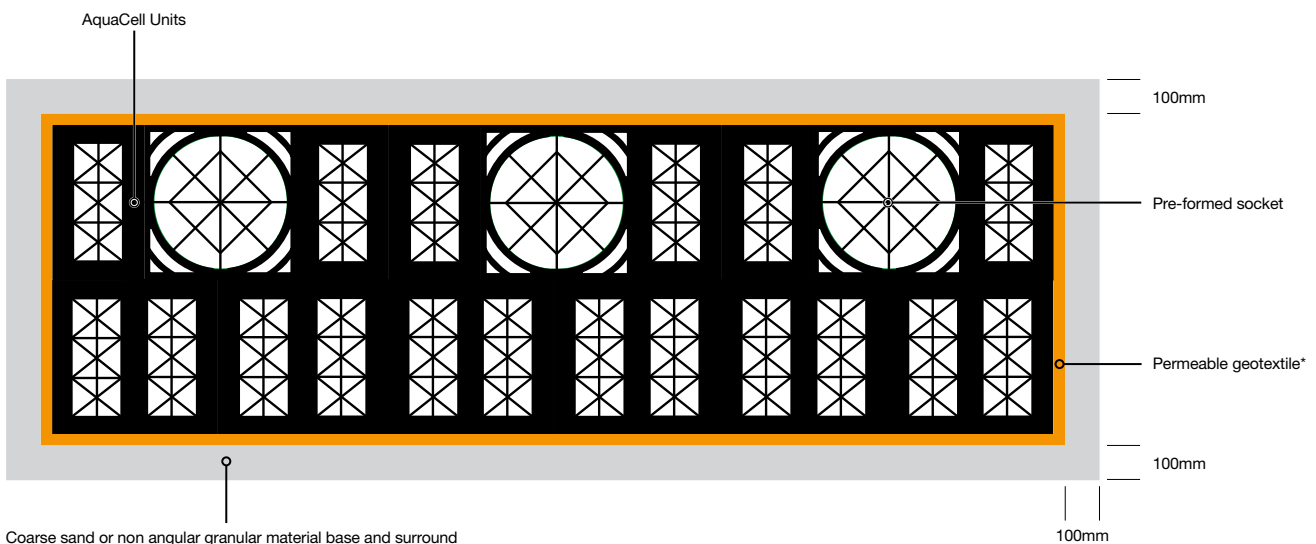

Example shows the use of AquaCell Eco. However, a soakaway can also be installed as shown using either of the other versions of AquaCell units (Core-R or Plus-R) as appropriate.

**The geotextile should be selected according to specific site conditions. Specialist advice should be sought if surrounding soil characteristics exhibit a high degree of fines/low infiltration capacity and/or there is a high risk of damage from ground contaminants.*

Typical storage tank installation method

Typical installation procedure

1. Excavate the trench to the required depth ensuring that the plan area is slightly greater than that of the AquaCell units.
2. Lay 100mm bed of coarse sand or non-angular granular material, level and compact.
3. Lay the geotextile¹ over the base and up the sides of the trench.
4. Lay the geomembrane² on top of the geotextile over the base and up the sides of the trench.
5. Lay the AquaCell units parallel with each other. In multiple layer applications, wherever possible, continuous vertical joints should be avoided. AquaCell units can be laid in a 'brick bonded' formation (i.e. to overlap the joints below) – see page 16. For single layer applications use the AquaCell Clips and for multi layers use the AquaCell Clips and the AquaCell Shear Connectors (vertical rods).
6. Wrap the geomembrane around the AquaCell structure and seal to manufacturers recommendations.*
7. If side connections into the AquaCell units is required, (other than the preformed socket), use the appropriate Flange Adaptor (6LB104 or 6LB106). Fix the flange adaptor to the unit using self-tapping screws. Drill a hole through the Flange Adaptor and connect the pipework. (6LB106 should not be used with AquaCell Eco).
8. In order to prevent silt from entering the tank, clogging inlet pipework and reducing storage capacity, it is recommended that the Domestic Silt Trap (6LB300) or the standard Silt Trap (6LB600) is installed prior to the inlet pipework – see page 20 for installation guidelines.
9. Wrap and overlap the geotextile covering the entire AquaCell structure, to protect the geomembrane.
10. Lay 100mm of coarse sand or non angular granular material between the trench walls and the AquaCell structure and compact.
11. Lay 100mm of coarse sand or non angular granular material over the geotextile/geomembrane and compact.
12. Backfill with suitable material.

NB: A storage tank must be vented, and it is recommended that one vent pipe, 110mm in diameter is provided per 7,500 square metres of impermeable catchment area on a site, see page 20 for design.

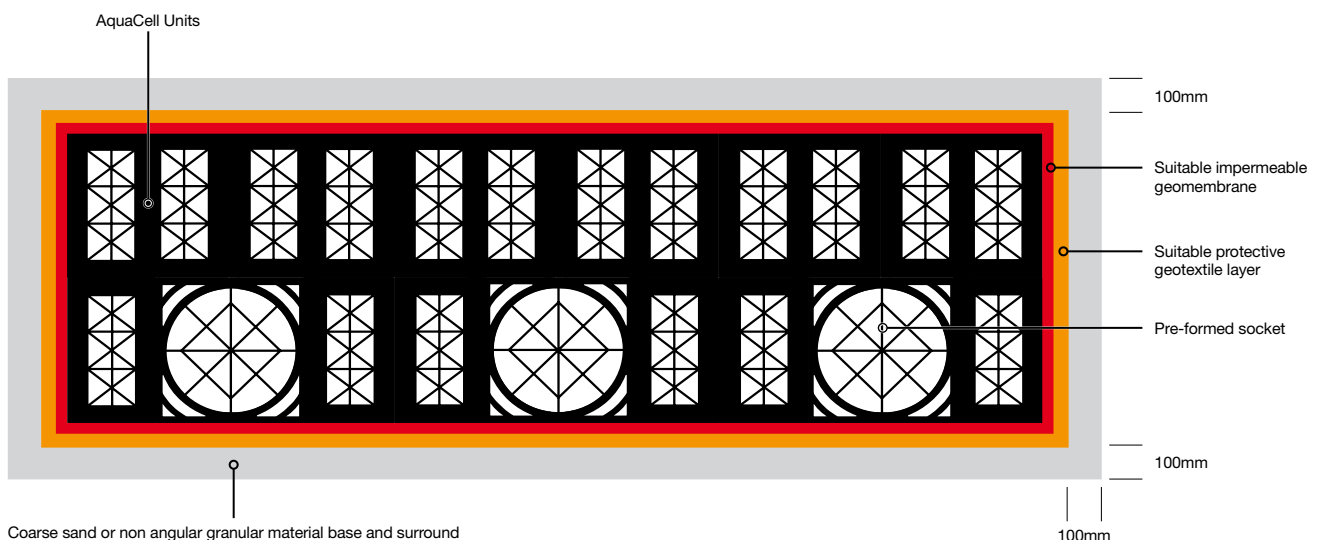

Example shows the use of AquaCell Core-R. However, a storage tank can also be installed as shown using any of the other versions of AquaCell units (Eco, Core-R or Plus-R) as appropriate.

1. For protective geotextiles CIRIA C753 – The SuDS Manual recommends a geotextile of at least 2mm thick and 300gsm.

2. The geomembrane should be designed to survive the rigours of construction, this is typically at least 0.5mm thick. Joints should be sealed using proprietary welding techniques.

Installation

Silt Trap and Air Vent termination

Silt Trap

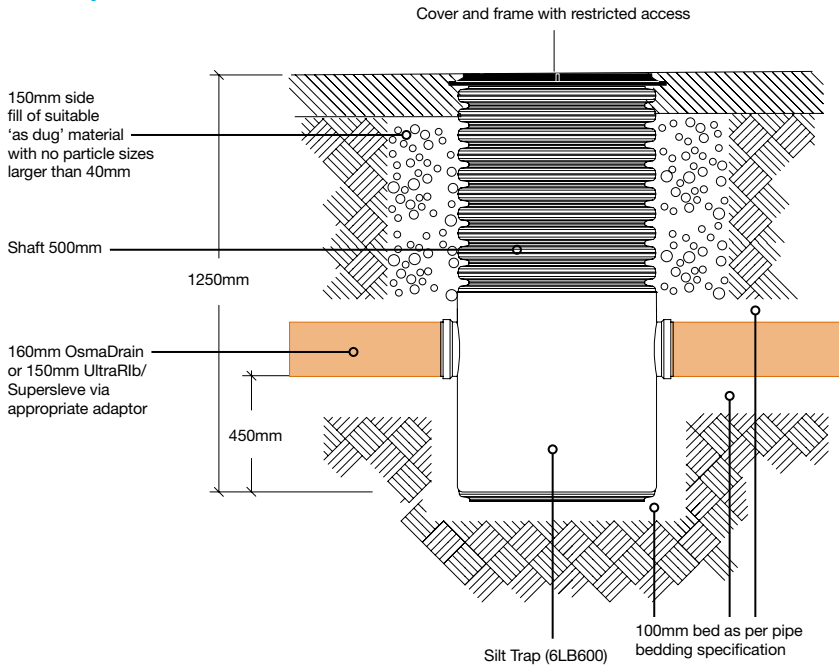

Typical installation procedure

1. Place the Silt Trap (6LB600, 6LB625, 6LB630) on a minimum of 100mm bed as per pipe bedding specification. Ensure that the trap is as close to the AquaCell unit as possible and in a suitable position to allow pipework connection.
2. Connect the relevant pipework in accordance with standard pipe installation guidelines.
3. Surround the sides of the Silt Trap with 150mm of 'as dug' material, with no particle sizes larger than 40mm.
4. Fit relevant cover and frame.

NOTE: When surrounded by a concrete plinth (150mm x 150mm) the 4D920 Cover and Frame can be used in situations with a loading of up to 50kN (5 tonne).

Typical Air Vent design

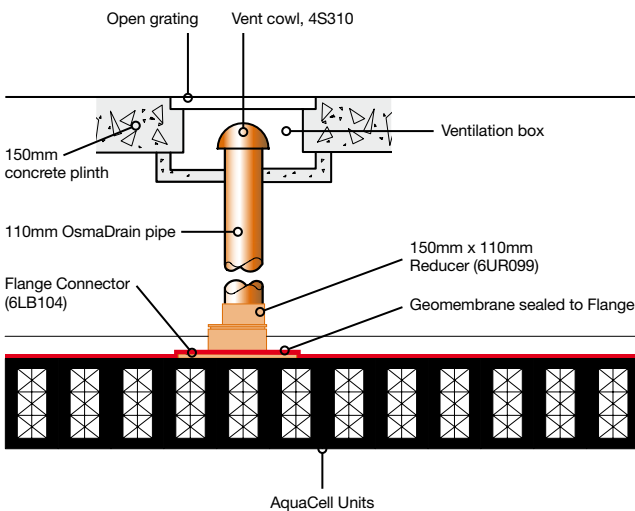

Typical Air Vent through manhole

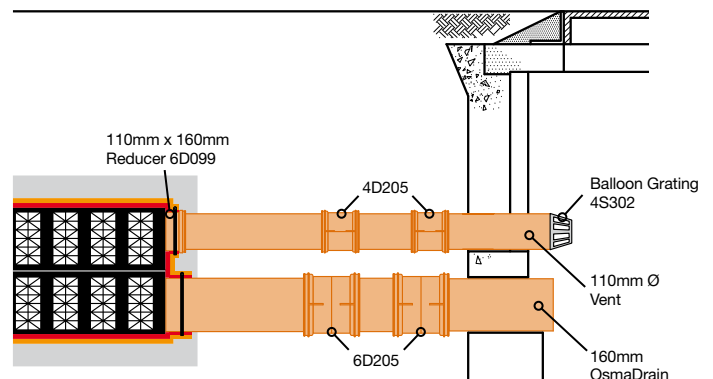

NOTE: It is recommended that all connections and air vent installations in storage applications (using geomembrane) are made using a Flange Adaptor.

Adhesive or double sided tape should be used between the geomembrane and the flange plate to ensure a watertight seal.

NOTE: It is recommended that one vent pipe, 110mm in diameter, is provided per 7,500 square meters of impermeable catchment area on a site. Please contact Wavin Technical Design for further details.

Connections

Top connection for Air Vent

Connect into the top of the AquaCell unit, using Flange Adaptor.

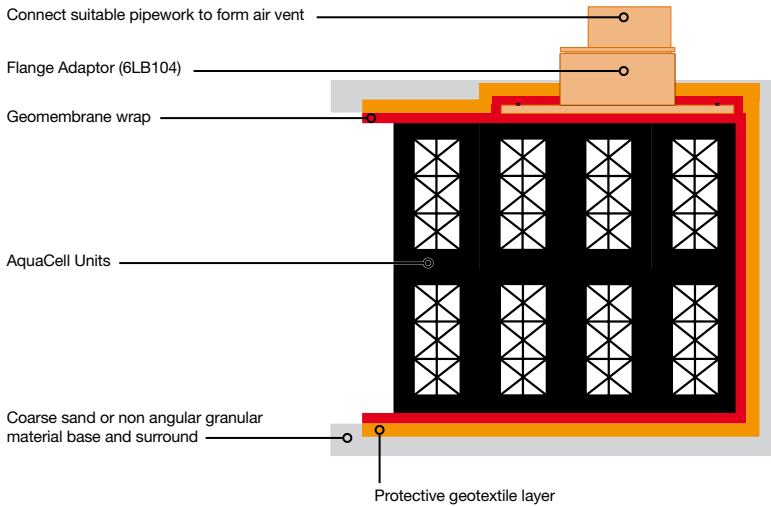

Typical installation procedure

1. Fix Flange Adaptor to the AquaCell unit with self tapping screws.
2. Cut through the geomembrane.
3. Insert pipework into Flange Adaptor to form air vent.

Side connection for Air Vent

Connect into the side of the AquaCell tank unit using standard Reducer.

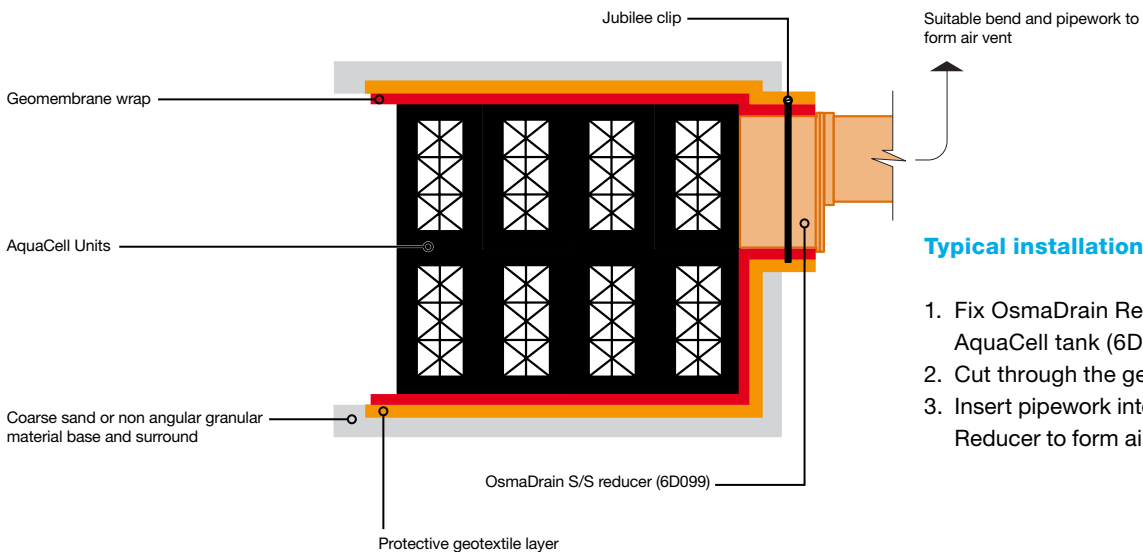

Typical installation procedure

1. Fix OsmaDrain Reducer to the AquaCell tank (6D099).
2. Cut through the geomembrane.
3. Insert pipework into OsmaDrain Reducer to form air vent.

Connections

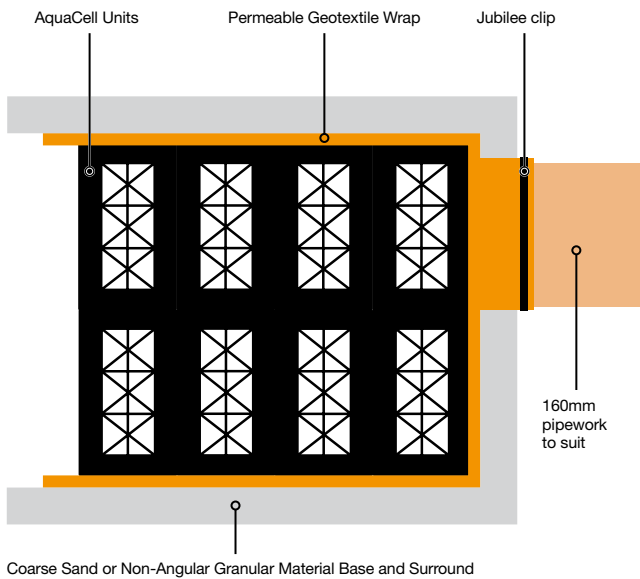

Connections to AquaCell units

Connection for soakaway application using either the pre-formed socket (as shown below) or standard adaptors into pre-formed socket*.

*NOTE: For pipework other than 160mm OsmaDrain, these adaptors can be used to connect to the following:

- ④ 6TW141: TwinWall S/S Adaptor connects to 150mm TwinWall
- ④ 6D099: OsmaDrain Adaptor connects to 110mm OsmaDrain
- ④ 6UR141: UltraRib S/S Adaptor connects to 150mm UltraRib
- ④ SA15/2: Double Spigot Adaptor connects 160mm OsmaDrain to 150mm Supersleve Clay

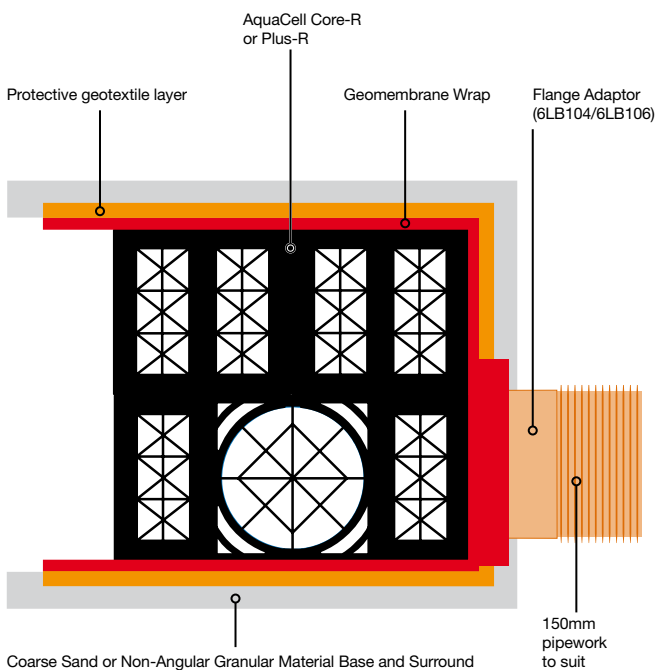

Connection for storage application using Flange Adaptor at points other than pre-formed socket, (for AquaCell Core-R or Plus-R).

Installation procedure

1. Fix Flange Adaptor to the AquaCell unit with self tapping screws.
2. Cut through the geomembrane.
3. Insert pipework into Flange Adaptor.

*NOTE: When using the 6LB104: For pipework other than 150mm UltraRib these adaptors can be used to connect to the following:

- ④ 6UR099: S/S Level Invert Reducer to 110mm OsmaDrain
- ④ 6UR143: UltraRib 150mm Spigot Adaptor connects to 160mm OsmaDrain
- ④ 6TW145: UltraRib 150mm Spigot Adaptor connects to 150mm Twinwall
- ④ TA/2: UltraRib 150mm Spigot Adaptor connects to 150mm Supersleve Clay

When using the 6LB106: For pipework other than 225mm UltraRib these adaptors can be used to connect to the following:

- ④ 9TW145: UltraRib 225mm Spigot Adaptor connects to 225mm Twinwall
- ④ TA/4: UltraRib 225mm Spigot Adaptor connects to 225mm Supersleve Clay

Connection configurations

The connections shown here in schematic form, are the typical options used to connect AquaCell units to control chambers. They provide a controlled feed into and out of the AquaCell units, and are used for either infiltration or attenuation schemes.

Manifold connection

Using standard pipes and fittings

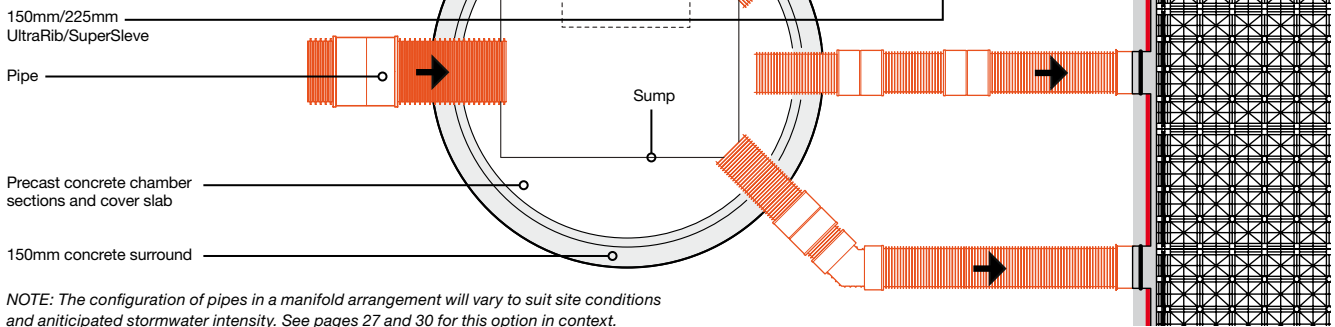

Box connection

Using AquaCell units for fast water transfer

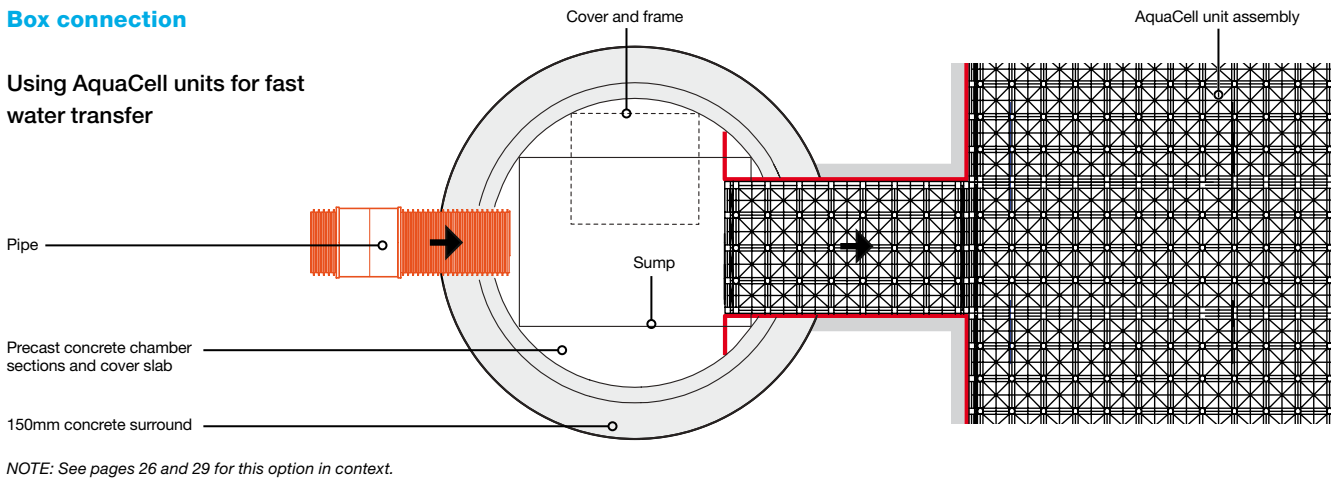

Central pipe connection

Using standard perforated Wavin TwinWall pipe and fittings

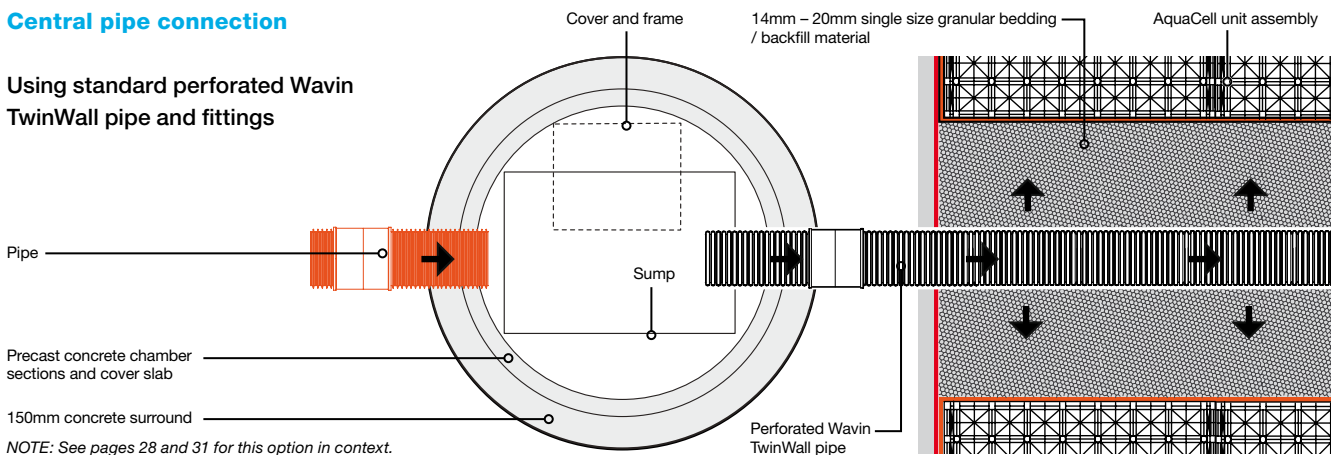

Soakaways

Soakaway – non-traffic loading

Soakaway

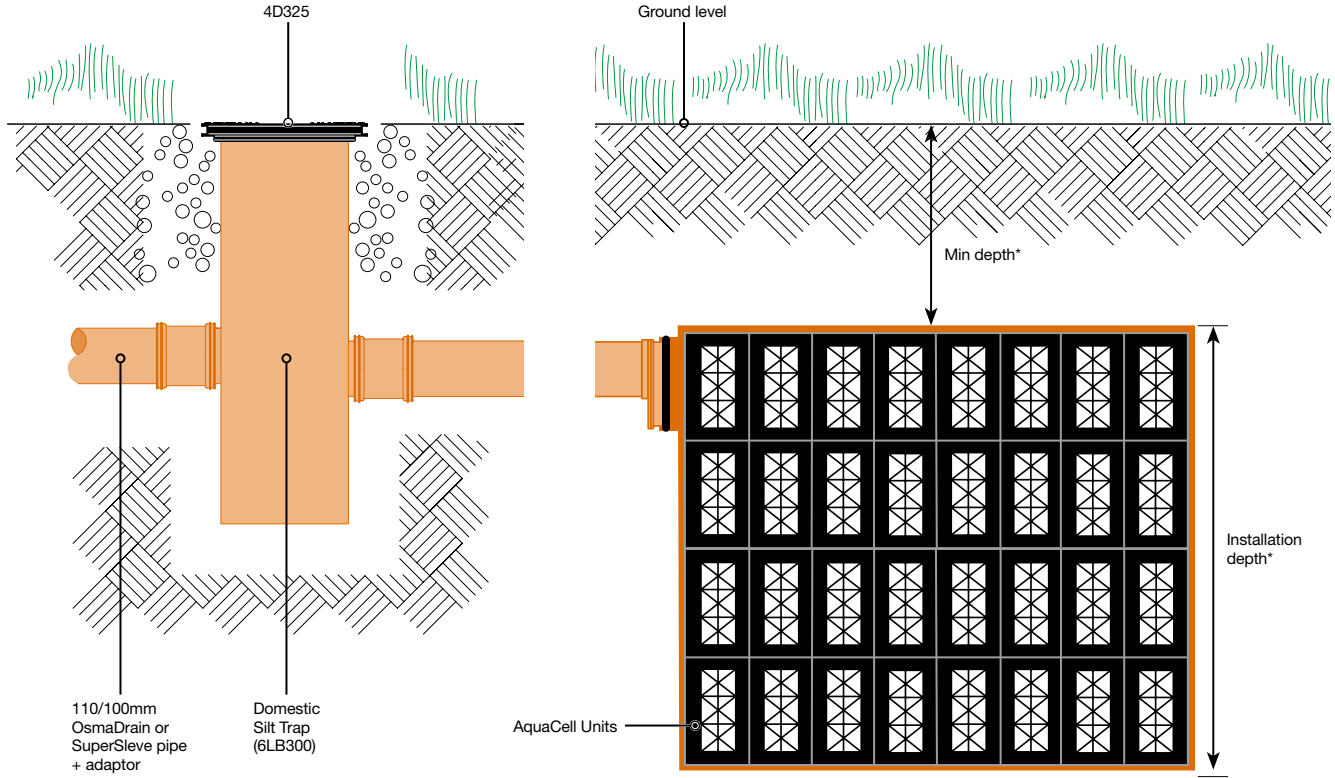

Trench soakaway

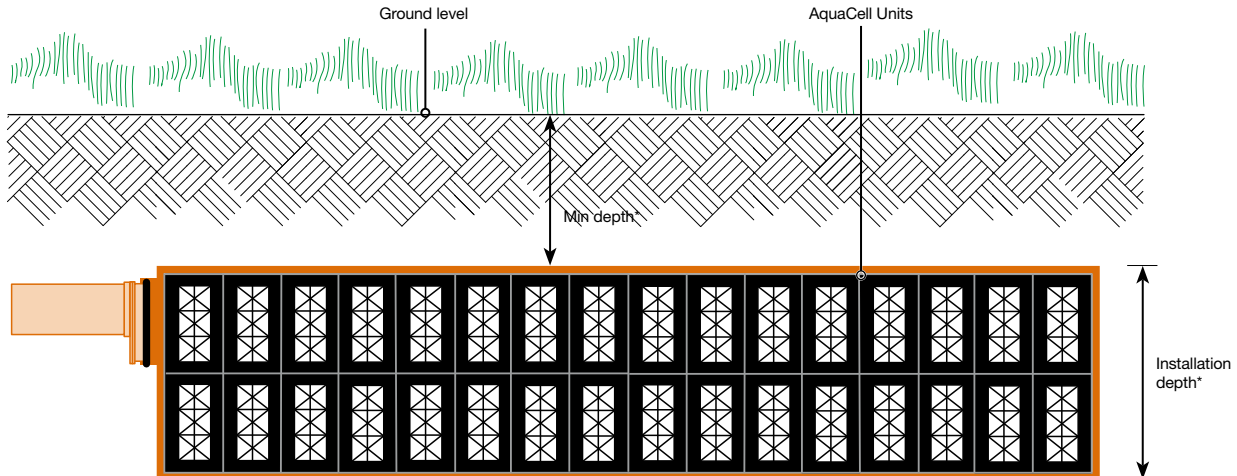

Notes

1. Soakaways should be sited at least 5m away from the building (Ref BS EN 752-4).
2. The exact size and shape of the soakaways are to be determined once all the necessary calculations have been produced.
*For information regarding cover depths and installation depths, see page 15.

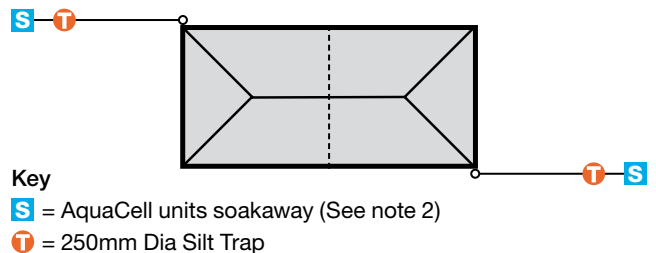

Soakaway – traffic loading

Soakaway

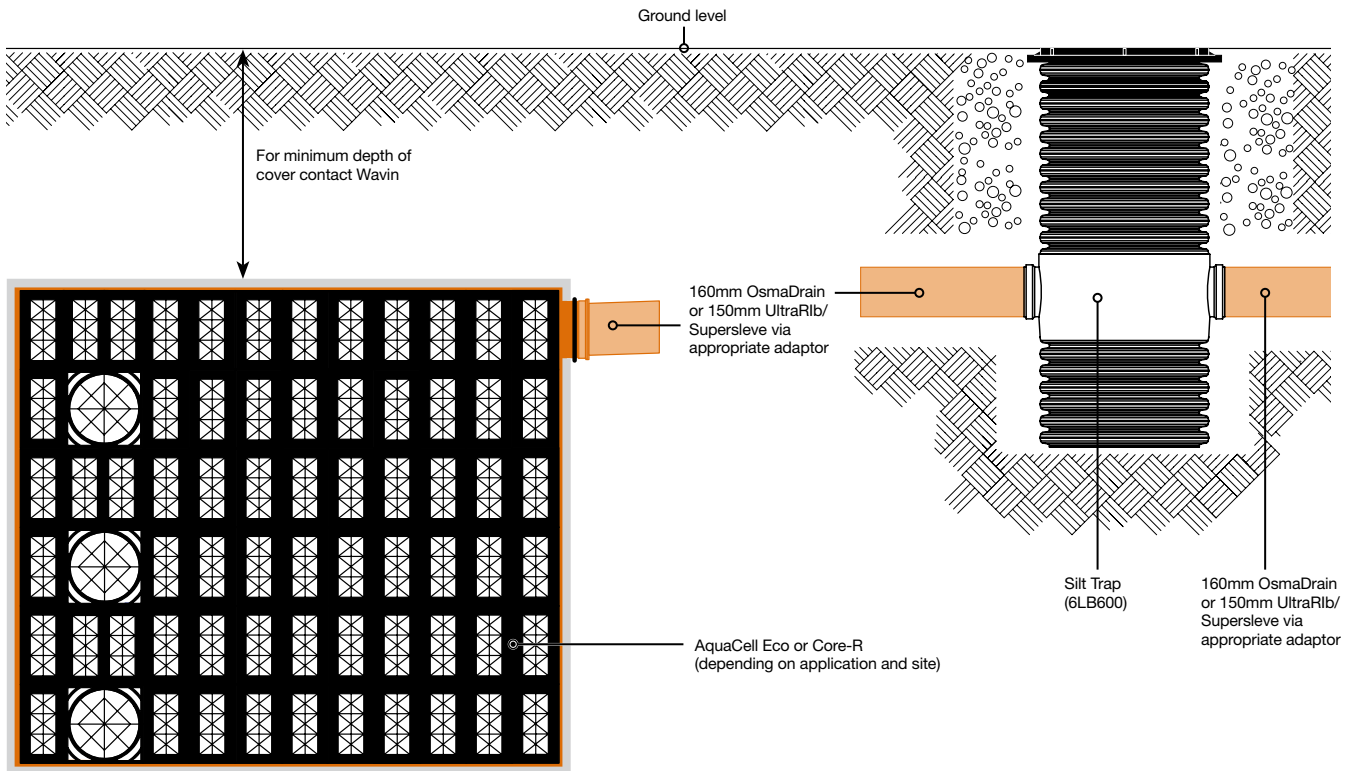

On-line storage

On-line storage – box feed

Long section

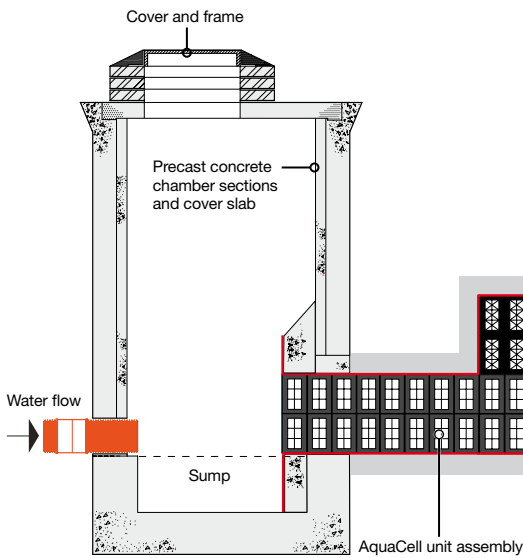

Typical vent detail

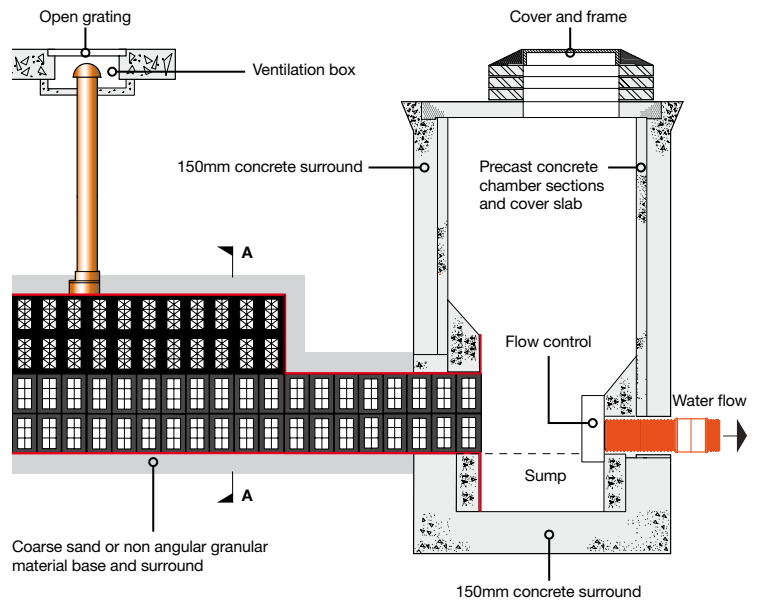

Plan

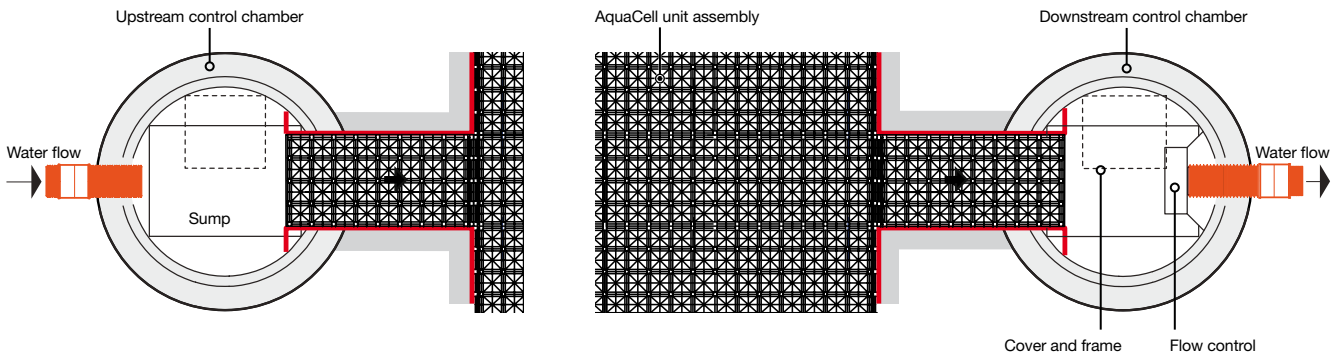

Cross section A-A

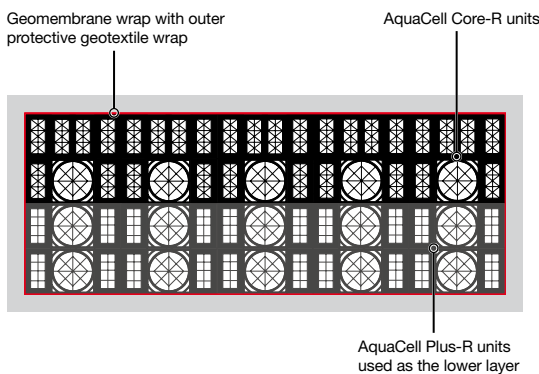

What happens to the water?

1. The water level in the upstream control chamber rises.
2. Then, during a storm event, the AquaCell storage assembly quickly fills with water via the AquaCell feed connection.
3. After storm event, water flows back out of the AquaCell storage assembly, finding its own level, and into the downstream control chamber.
4. The water then flows through the vortex flow control valve.

On-line storage – manifold feed

Long section

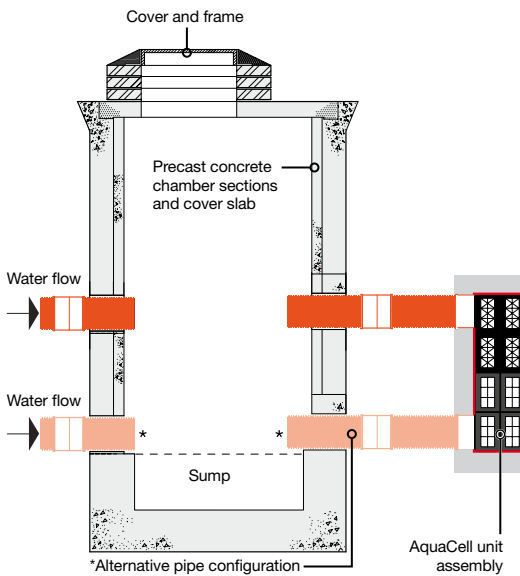

Typical vent detail

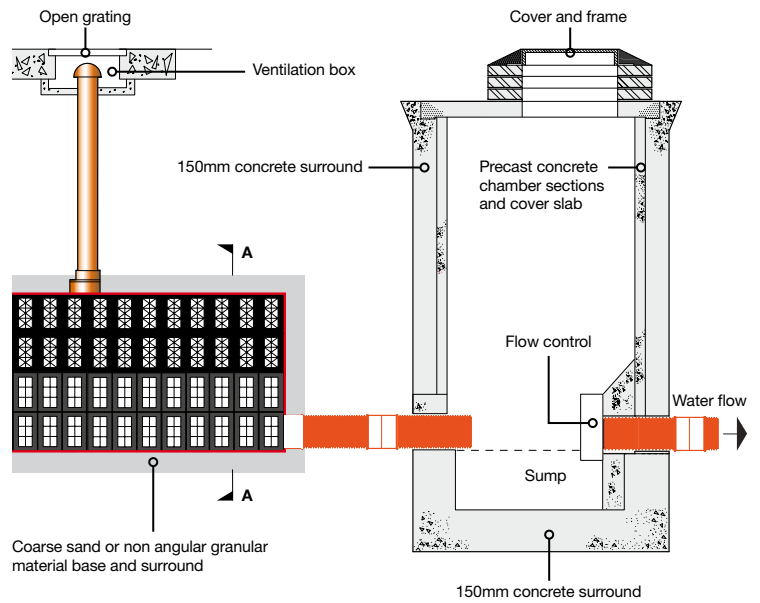

Plan

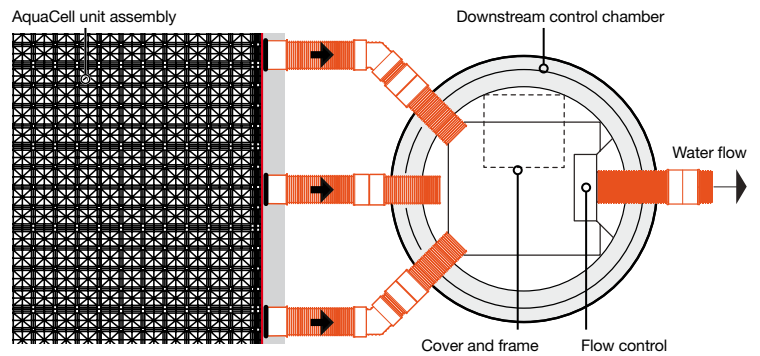
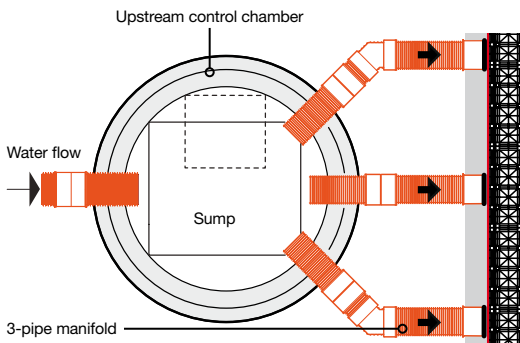

Cross section A-A

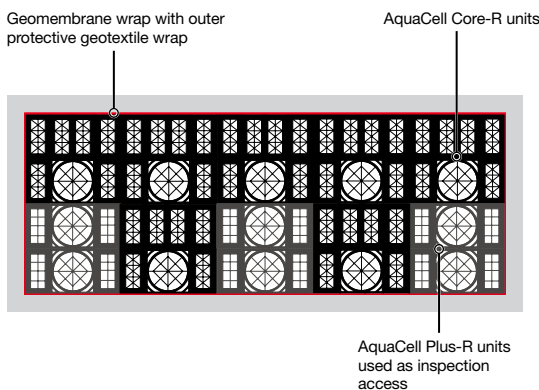

What happens to the water?

1. The water level in the upstream control chamber rises.
2. During a storm event, the AquaCell storage assembly fills with water via the manifold feed connection.
3. After storm event, water flows back out of the AquaCell storage assembly, finding its own level, and into the downstream control chamber.
4. The water then flows through the vortex flow control valve.

On-line storage

On-line storage – central pipe feed

Long section

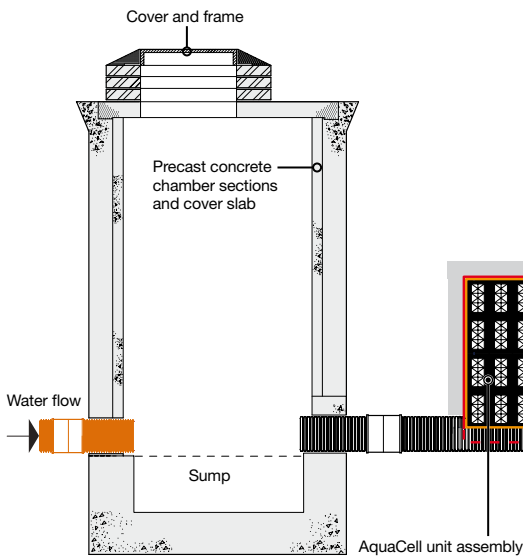

Typical vent detail

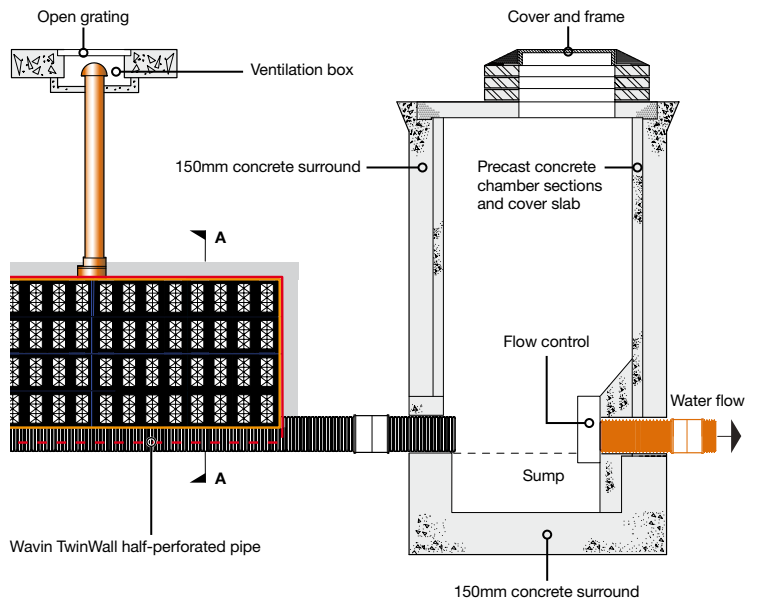

Plan

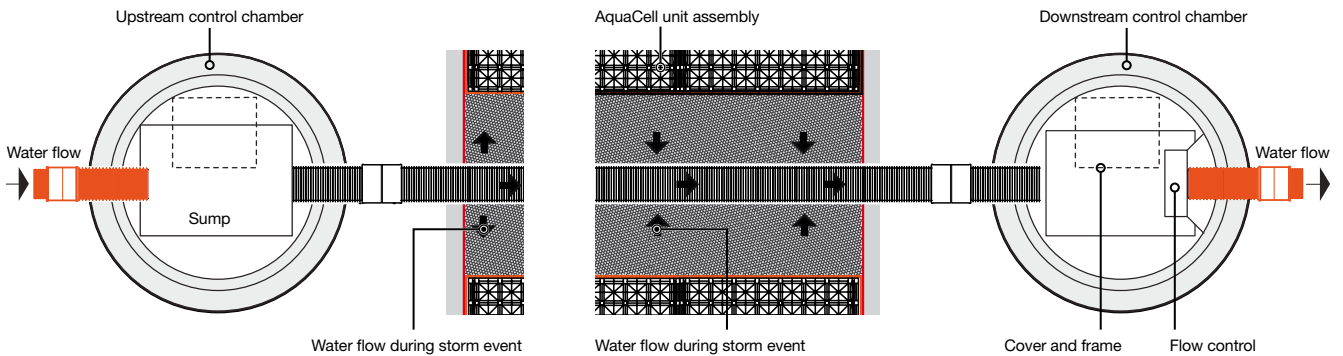

Cross section A-A

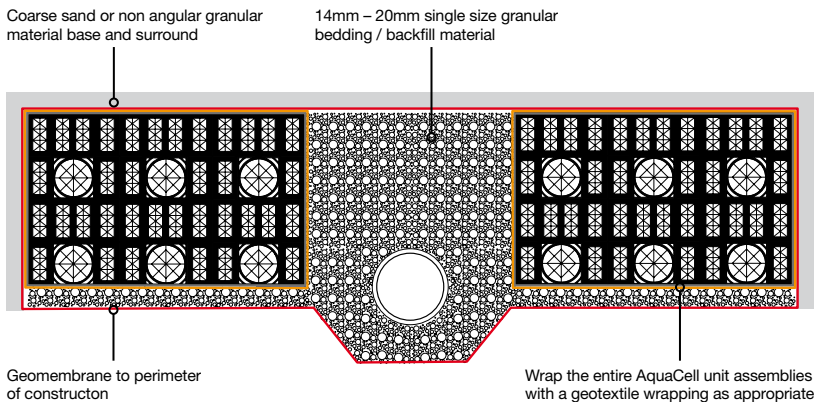

What happens to the water?

1. The water level in the upstream control chamber rises.
2. AquaCell storage assemblies fill with water via the central pipe connection and percolate's through the granular bedding material.
3. After storm event, water flows back out of the AquaCell storage assemblies, finding its own level, and into the downstream control chamber.
4. The water then flows through the vortex flow control valve.

Off-line storage

Off-line storage – box feed

Long section

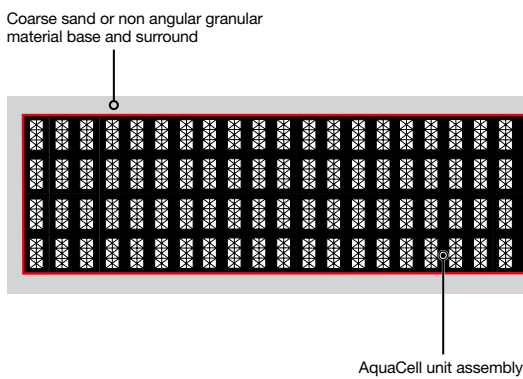

Typical vent detail

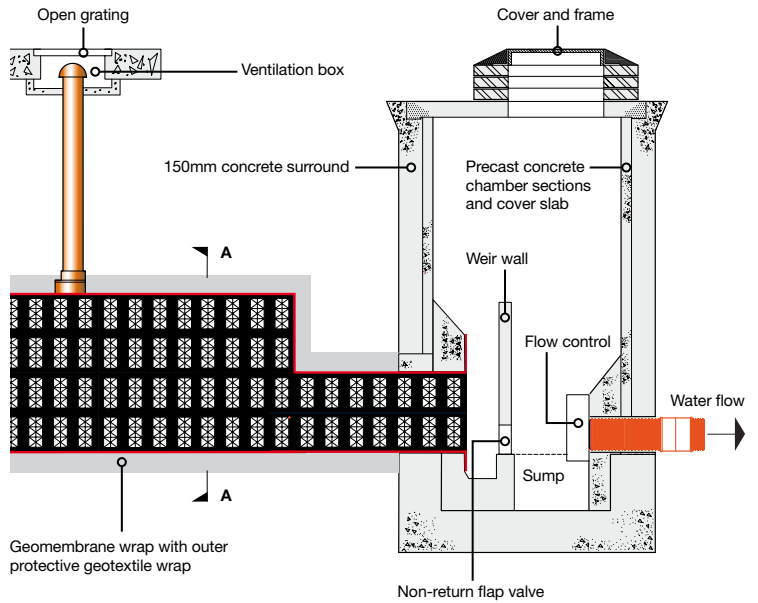

Plan

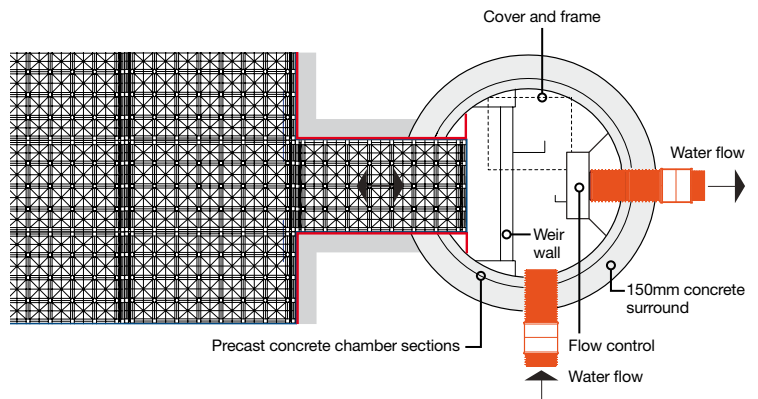
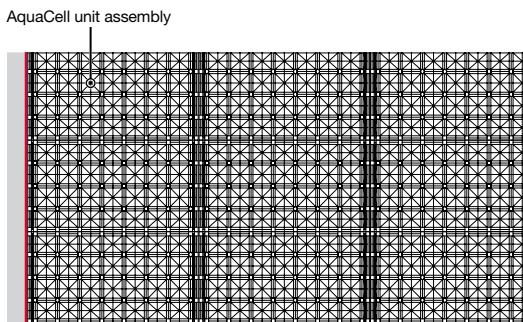

Cross section A-A

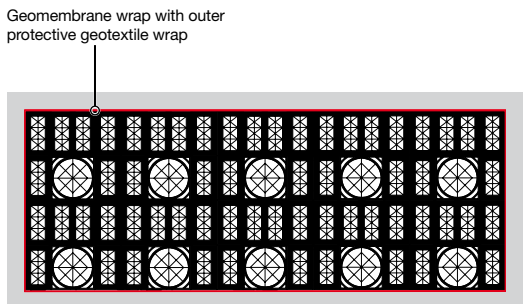

What happens to the water?

1. Control chamber fills with water, up to the top of the weir wall.
2. The water overflows the weir wall and enters the AquaCell storage assembly via the AquaCell connection.
3. The AquaCell storage assembly fills with water.
4. After storm event, water flows back out of the AquaCell storage assembly, finding its own level, and through the non-return flap valve at the bottom of the weir wall.
5. The water then flows through the vortex flow control valve.

Off-line storage

Off-line storage – manifold feed

Long section

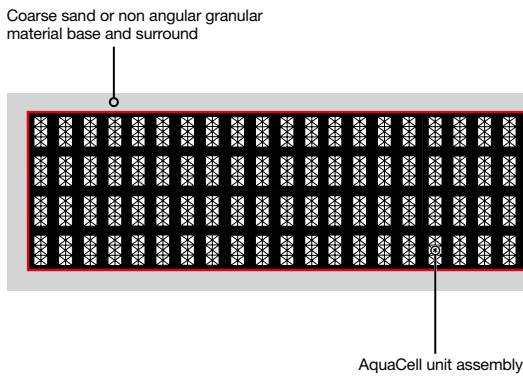

Typical vent detail

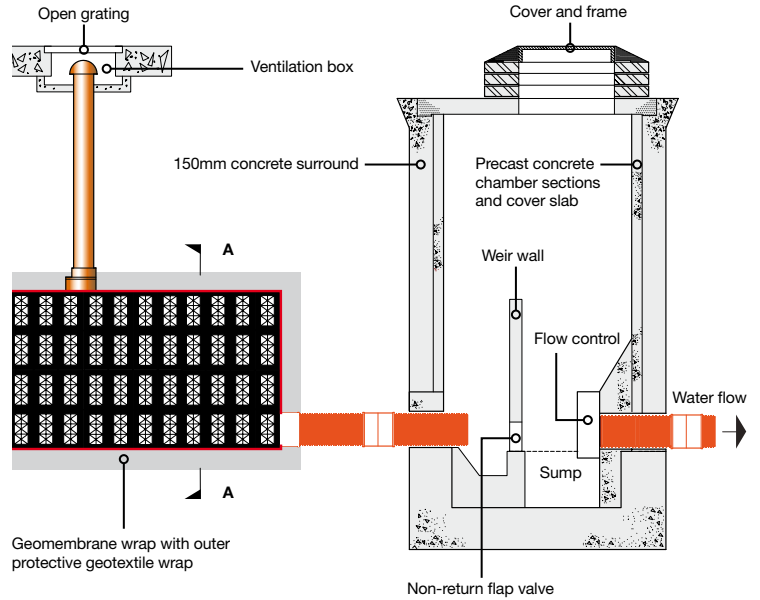

Plan

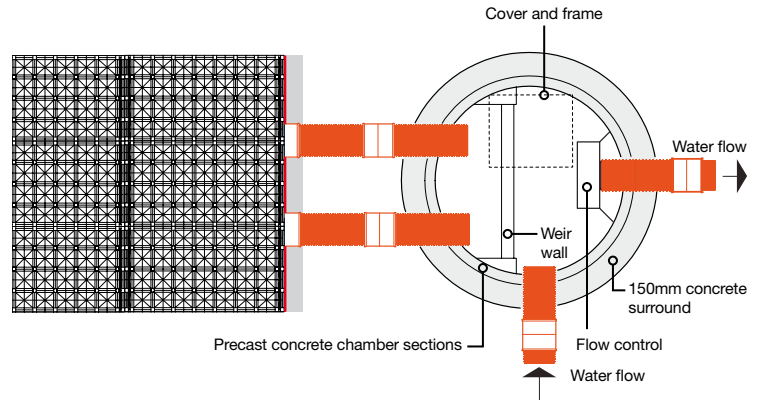
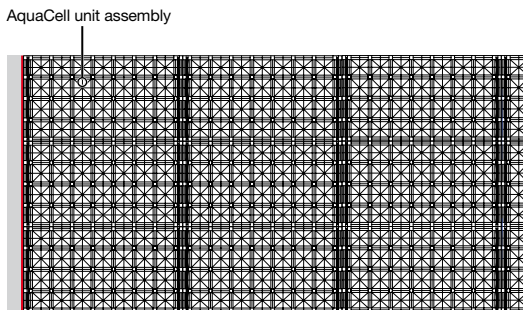

Cross section A-A

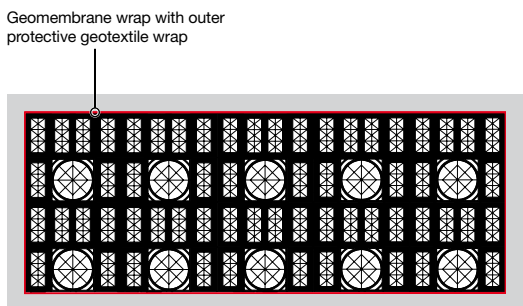

What happens to the water?

1. Control chamber fills with water, up to the top of the weir wall.
2. The water overflows the weir wall and enters the AquaCell storage assembly via the manifold connection.
3. The AquaCell storage assembly fills with water.
4. After storm event, water flows back out of the AquaCell storage assembly, finding its own level, and through the non-return flap valve at the bottom of the weir wall.
5. The water then flows through the vortex flow control valve.

Off-line storage – central pipe feed

Long section

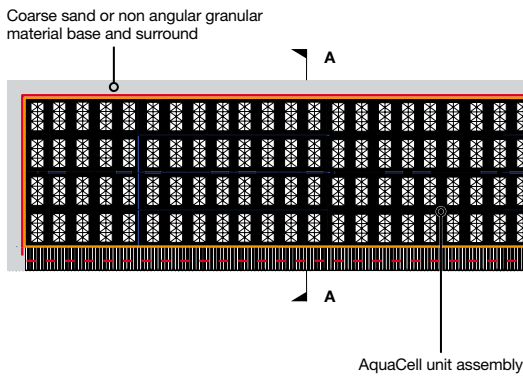

Typical vent detail

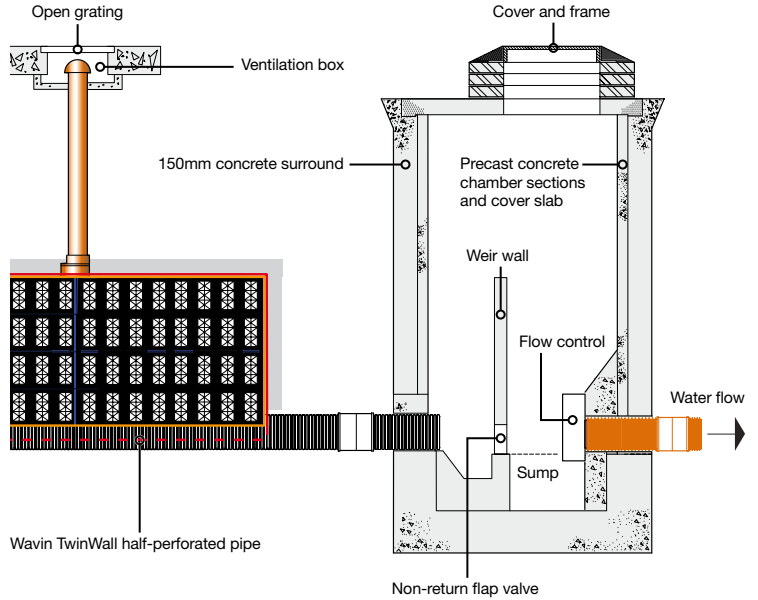

Plan

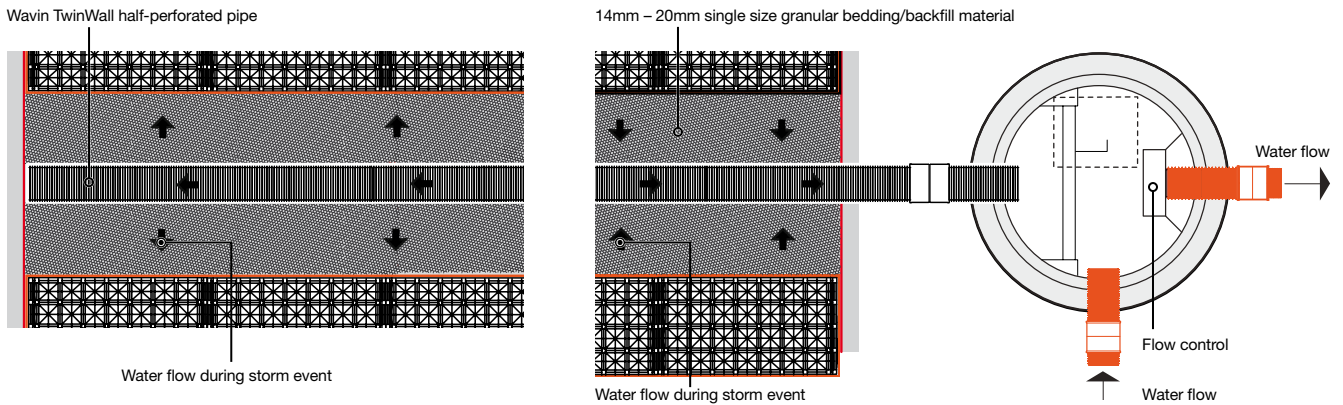

Cross section A-A

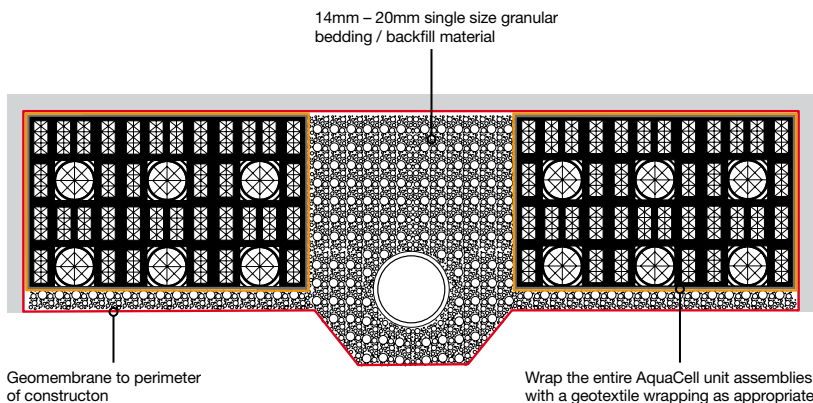

What happens to the water?

1. Control chamber fills with water, up to the top of the weir wall.
2. The water overflows the weir wall and enters the AquaCell storage assemblies via the central pipe connection and percolate through the granular bedding material.
3. The AquaCell storage assembly fills with water.
4. After storm event, water flows back out of the AquaCell storage assemblies, finding its own level, and through the non-return flap valve at the bottom of the weir wall.
5. The water then flows through the vortex flow control valve

Soakaway with Silt Trap

Soakaway or storage tank – with Silt Trap

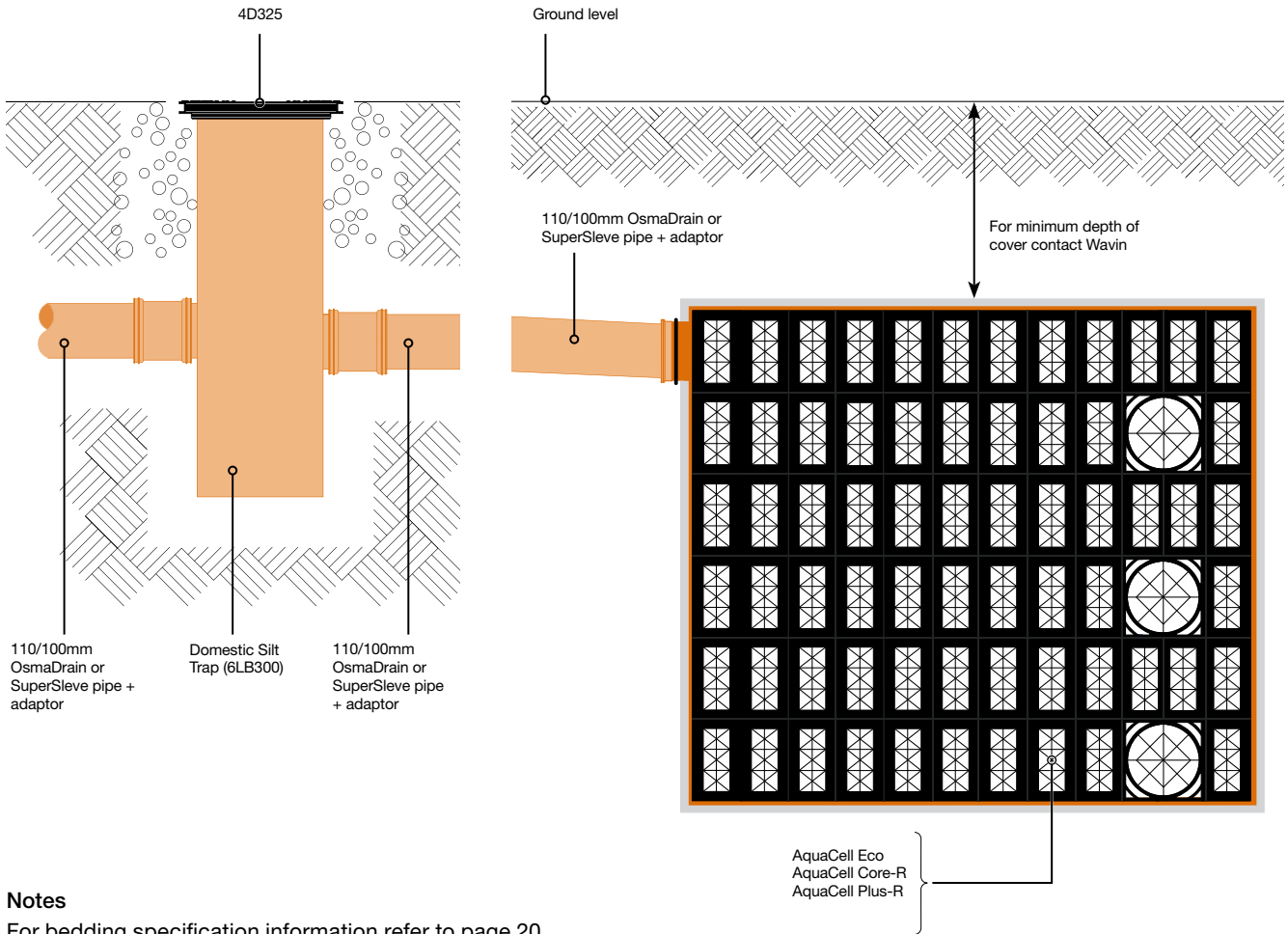

Notes

For bedding specification information refer to page 20.

The silt trap can be used in conjunction with a soakaway (as shown) or a storage tank.

AquaCell Eco
AquaCell Core-R
AquaCell Plus-R

(Choice depends on application and site conditions)

Wavin stormwater management

To achieve optimum stormwater management

The Wavin Stormwater Management System represents a combination of specialist expertise and technology from Wavin. This is specifically focused on achieving the optimum solution for each project requiring effective and sustainable management of stormwater.

Such a solution may be entirely based on a tailored combination of our engineered systems.

In other cases, Wavin Stormwater Systems can be integrated with 'soft' SuDS techniques, such as ponds and swales, to help achieve the optimal solution.

Other Wavin stormwater systems

Channel drainage

Environmentally-friendly polyester concrete systems to cover all EN 1433 load classes. With outstanding chemical resistance and low water absorption:

- ⌚ Medium duty range for applications up to C250
- ⌚ Heavy duty range for D400 / F900 application

Plastic pervious paving

High performance, plastic pervious paving system, for use in all types of Sustainable Drainage systems (SuDS).

- ⌚ AquaGrid 50 – for use in landscape projects
- ⌚ AquaGrid 75 – for use in car parking areas

Flow control valves

The Wavin+Mosbaek range of vortex flow control valves are manufactured from stainless steel and are custom-built to meet exact site requirements:

- ⌚ Tornado, Hurricane and Typhoon stainless steel flow control valves with no moving parts of power needs

Q-Bic Plus

As part of an effective SuDS solution, no other attenuation tank ticks as many boxes as Q-Bic Plus.

Designed from the ground up to be compliant with Sewers for Adoption 8, it is easy to handle, fast and simple to install, and carries BBA approval. The high void design makes it the most accessible, inspectable and cleanable attenuation tank on the market, scoring with specifiers for its design flexibility whatever the soil type, available area or load.

Anti-flood valves

- ⌚ Anti-Flood Valves that comply with EN 13546-1, and Part H1– Sections 2.8-2.12 of Building Regulations

Below ground water transportation

Wavin Stormwater installations can draw from an extensive choice of plastic and clay pipe systems, including:

- ⌚ OsmaDrain solid wall PVC-U pipe system
- ⌚ Structured wall plastic UltraRib and TwinWall pipe systems
- ⌚ SuperSleeve clay pipe systems

Other options include perforated pipe for land drainage: WavinCoil plastic and HepLine clay – and a full range of Wavin Non-Entry Inspection Chambers.

The Wavin stormwater service

Precision and performance

The Wavin Technical team are ready to contribute to any stormwater management project.

This may be at the very earliest stage – or when initial plans have already been developed. There are no pre-conditions with regards to you requesting Wavin to become involved.

We are ready to:

- ⌚ Originate project design
- ⌚ Comment on an existing design
- ⌚ Help validate a specification – or, where we see an opportunity to do so, to suggest how it may be enhanced
- ⌚ Check, clarify and confirm maximum cost-efficiency, performance capability and regulatory compliance

This involvement is a core part of the Wavin principle. It extends beyond the systems and components.

To discuss your stormwater management project, call 0800 038 0088 or email technical.design@wavin.co.uk.

Supplementary items

Silt Trap – domestic – for non loaded applications

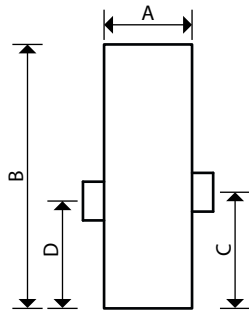

Domestic Silt Trap

- 250mm x 750mm depth
- With 110mm diameter inlet and outlet spigots
- For use with the 4D325 cover and frame

Material: PVC-U

Nominal Size (mm)	Part Number	Dimensions (mm)			
		A	B	C	D
-	6LB300	250	750	330	305

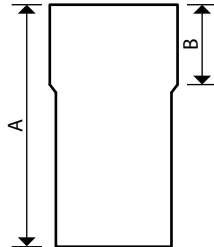

Extension Piece for 6LB300

- 250mm x 500mm depth (effective length = 335mm)

Material: PVC-U

Nominal Size (mm)	Part Number	Dimensions (mm)	
		A	B
-	6LB301	500	165

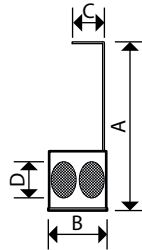

Silt Trap Bucket for 6LB300

- 200mm x 210mm depth

Material: PVC-U/Polypropylene

Nominal Size (mm)	Part Number	Dimensions (mm)			
		A	B	C	D
-	6LB302	597	208	114	127.5

Silt Trap – trafficked

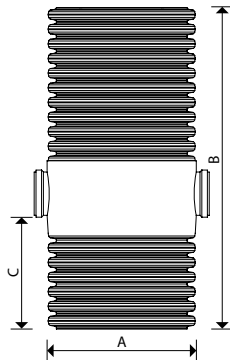

Silt Trap

- 500mm diameter x 1.25m depth

Material: Polypropylene

Nominal Size (mm)	Part Number	Dimensions (mm)		
		A	B	C
160mm	6LB600	500	1250	450
225mm	6LB625	500	1250	450
300mm	6LB630	500	1250	450

Ancillaries

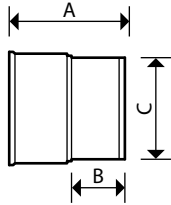

S/S Adaptor

- 6UR socket x 160mm BS EN 1401 spigot

Material: PVC-U

Nominal Size (mm)	Part Number	Dimensions (mm)		
		A	B	C
150	6UR141	180	84	160

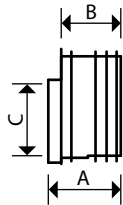

S/S Level Invert Reducer

- To 110mm OsmaDrain spigot

Material: PVC-U

Nominal Size (mm)	Part Number	Dimensions (mm)		
		A	B	C
150 x 110	6UR099	115	95	111

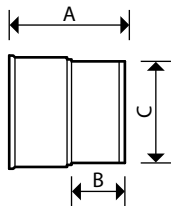

S/S Adaptor

- 6TW socket x 160mm BS EN 1401 spigot

Material: PVC-U

Nominal Size (mm)	Part Number	Dimensions (mm)		
		A	B	C
150	6TW141	180	84	160

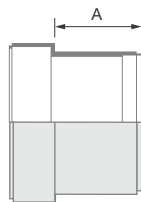

Double Ended Spigot Adaptor

- For connecting SuperSleve pipes to OsmaDrain pipes

Material: Polypropylene

Nominal Size (mm)	Part Number	Dimensions (mm)
		A
100	SA15/1	65
150	SA15/2	80

Supplementary items

Ancillaries

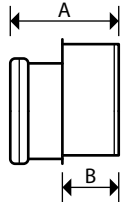

S/S Level Invert Reducer

- To 110 OsmaDrain

Material: PVC-U

Nominal Size (mm)	Part Number	Dimensions (mm)	
		A	B
160	6D099	127	70

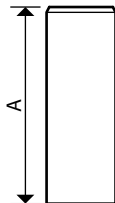

P/E Adaptor

- 160mm spigot connection

Material: PVC-U

Nominal Size (mm)	Part Number	Dimensions (mm)
		A
160	4D916	325

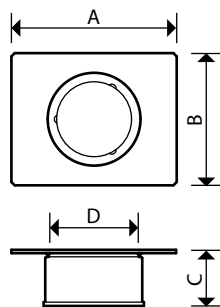
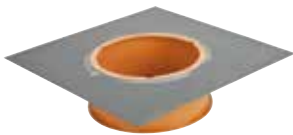

Flange Adaptor

- 6UR socket for connection of UltraRib to infiltration unit at positions other than preformed opening
- 9UR socket for connection of UltraRib to infiltration unit (can only be used with AquaCell Core-R and Plus-R)

Material: PVC-U

Nominal Size (mm)	Part Number	Dimensions (mm)			
		A	B	C	D
150	6LB104	300	300	100	160.3
225	6LB106	500	400	120	226.5

Spares



AquaCell Clip

- For jointing all AquaCell units horizontally

Material: Polypropylene

Nominal Size (mm)	Part Number
–	6LB105



AquaCell Shear Connector

- For jointing all AquaCell units vertically

Material: Polypropylene

Nominal Size (mm)	Part Number
–	6LB102



AquaCell Plus End Cap

- For blocking off unused inlets/outlets

Material: Polypropylene

Nominal Size (mm)	Part Number
–	6LB202

Your notes

Discover our broad portfolio at
www.wavin.co.uk



Water management | Plumbing and heating | Waste water drainage
Water and gas distribution | Datacom



Wavin is part of Orbia, a community of companies working together to tackle some of the world's most complex challenges. We are bound by a common purpose: To Advance Life Around the World.



Wavin Limited
Registered Office | Edlington Lane | Doncaster | DN12 1BY
Tel. 0800 038 0088 | www.wavin.co.uk | info@wavin.co.uk