



Stylish. Secure. Solidor®

solidor.co.uk



“What does your front door say about you?”



Solidor
Leading the way in secure composite doors



Introduction

The Solidor Collection is an outstanding range of industry leading, solid timber core composite doors. Each Solidor exceeds building regulation requirements and combines traditional and contemporary styling with a full range of Secured by Design locking systems, high quality and secure entrance to any home.

With a thickness of 48mm, a Solidor door is nearly 10% thicker than most alternatives. Each unique solid timber core is completely encapsulated within a highly durable plastic edge banding and two thermo plastic door skins.

These doors are exclusively available in the widest range of styles and frame colour options, (24 colours available, please see page 8) with the option of a mobility threshold, making it the perfect solution for easy wheel or push chair access. We offer a comprehensive range of matching coloured frames, that are available with either glass, composite side panel or quarter panel to complement the look of any property.

Solidor composite doors are manufactured to the highest standards. We hold BSI Kite mark accreditation BSI ISO 9001 for quality management, BSI EN1279 for insulating glass units.

We are also PAS24:2016 certified, hold CE Marking and Secured by design licences, and are members of the prestigious GGF and Association of Composite Door Manufacturers.

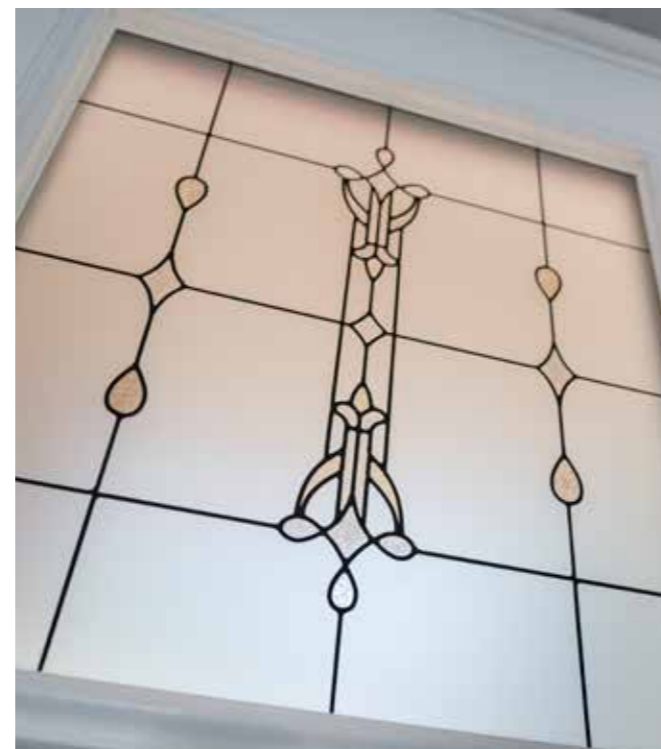

Contents

- 05. Choosing Solidor
- 06. Security
- 08. Colour Options
- 11. The Italia Collection
- 20. The Traditional Collection
- 30. Solidor French Doors
- 32. Solidor Stable Doors
- 36. Side Panels
- 38. Furniture & Accessories
- 43. Finishing Options
- 41. Glazing Options
- 44. Artistic Glass
- 46. Traditional Range
- 47. Decorative Glass

PLEASE NOTE THE IMAGES SHOWN WITHIN THIS BROCHURE ARE FOR ILLUSTRATION PURPOSES ONLY. PLEASE USE THIS BROCHURE AS A REFERENCE, SLIGHT CHANGES CAN OCCUR DUE TO CONTINUOUS IMPROVEMENT.

Choosing Solidor®

We understand that knowing your home and family are protected is a major factor when choosing a new door.

You can rest assured that with our door construction, coupled with our unique, reinforced door frame and Secured by Design locking systems, your home will be as safe as can be when you choose Solidor.

A typical foam filled door construction

40mm Foam Filled Centre
performs thermally, but because this is a foam fill it is neither solid, nor secure.

Visible Edge Banding
as a result you will often see a different coloured line running the length of the door.

Gel Coated GRP Outer Skin
may offer protection but can be easily cut through. Also, because every door is a white blank that is surface painted they show scratches very easily.

3 Chamber Profile
which use valuable steel or aluminium reinforcements. Also, you should check if they are lead free.

Solidor's unique solid timber construction

44mm Solid Timber Core (48mm including skin) that is thermally efficient and extremely secure.

Hidden Edge Banding
so the front of your door remains a solid, glorious slab of colour.

'Through' Colour ABS Skins
made from the same durable plastic as Lego®. Also, because the entire skin is made of a solid colour, any scratches are practically hidden.

Lead Free, 5 Chamber Profile
which uses 100% recycled reinforcing. Generally, the more chambers that a profile uses, the stronger and more thermally efficient they are.

Wood Grain Effect Skin
that gives all of the aesthetics of timber, but without the time consuming maintenance.

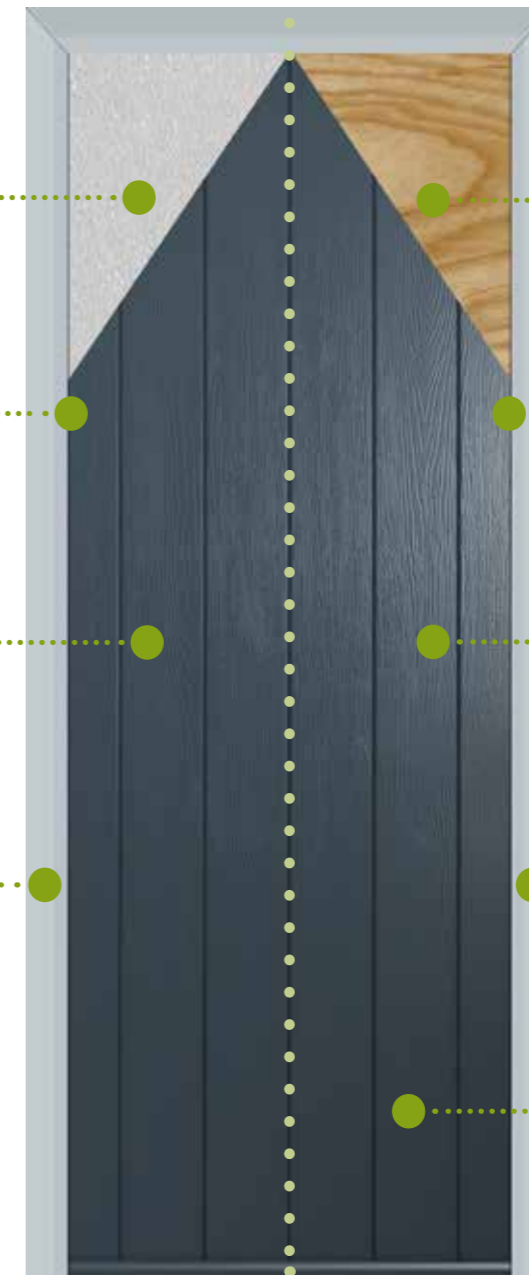

To see our security test video visit www.solidor.co.uk/tv



Reasons to feel Safe & Secure

You can rest assured that with our door construction, coupled with our unique, reinforced door frame and Secured by Design locking systems, your property will be as safe as can be when you choose Solidor.



Ultion Cylinder

The Ultion cylinder prides itself upon 3 star plus protection. With 85% of break ins occurring through lock snapping, the Ultion hidden attack lock means it can detect an attack and automatically activate lockdown mode.

As well as offering 20-point drill protection whereby steel pins are positioned precisely to ensure your cylinder is drill safe, it is also tested by the Master Locksmith Association and achieves the highest kitemark star rating available.



Avantis Multi-point Locking

As standard we fit our exclusive Avantis Secured by design locking systems. With larger hooks for added strength.

Different locking systems we offer :

- Avantis multi-point lock
- Standard slam shut auto lock
- Heritage slam shut lock
- Key operated multi
- AV3 Slam shut lock



48mm Solid Timber Core

At Solidor, security and safety are amongst our highest priorities. Sadly a property is burgled in the UK every minute, but our 48mm* thick solid timber core gives you the strongest and most secure option available in a residential door.

*44mm Solid Timber Core (48mm including skin)



ABS Cylinder

The new ABS Master lock provides the reassurance you need where home security is concerned. Featuring patent protected snap secure technology, the ABS Master cylinder recognises when an attack is taking place, and the break secure technology creates a barrier to access. However the locks integrity is maintained and can still be operated from the inside.

When it's you entering your home however, with no jagged edges the key glide and operation is second to none and promises comfortable operation and fault free security.



Lock Options



The Largest Deadbolt in the UK!

On lever handle doors we fit our Avantis Secured by Design lock. This has the industry's largest 25.4mm deadbolt for added security.

It also has built in compression and dampeners to give the smoothest operation on the market.

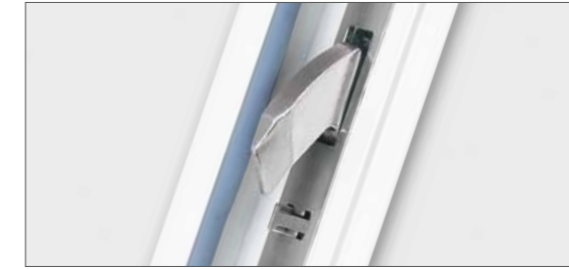

Automatic AV2 Mech Lock

The automatic AV2 mechanical lock operates as a slam secure lock as soon as the door is closed.

AV2-E is our electronic locking system which incorporates a 12v electric motor, causing the mechanism to withdraw the hooks and latch. The motor can be powered by a door entry system of the homeowners choice (door entry system to be sourced separately).



Automatic AV3 Mech Lock

The new autoLock AV3 automatic multi-point locking system has a magnetic trigger in the frame. Two self-locking sturdy hooks provide security and two sealing elements ensure correct closure.

A daytime release function is integrated as standard with easy one-handed operation or motorised release.



Avocet £2000 Guarantee

You can be sure your Solidor is secure when fitted with the Avocet ABS Cylinder. If an intruder gains access to your home through snapping the Avocet cylinder lock, Avocet will pay you £2000.



Lock Positioning



Standard Slam Shut Auto lock

The Slam Shut lock is an automatic multi-point locking system. It features two self-locking hooks to provide additional security and two sealing elements ensure correct closure.



Heritage Slam Shut Lock

The aesthetics of a traditional rim latch, but incorporates the latest high security slam shut technology. The lock automatically engages as the door closes.



Key Operated Multi-Point Lock

Customers who do not want handles can upgrade to our key operated multi-point lock.

Supreme Security Accreditations



A Colourful Entrance

4 new colours added to the range for 2023

We offer the **largest** range of colours from stock in the UK.

Choose from 24 colours for the inside and / or the outside of your door. You also have 9 frame colour options to choose from. When selecting your colour from this guide please be aware we advise you to ask for a colour swatch to check both colour and grain structure.

Luxury Range



RAL Colour Match for Solidor Door Skins

- | | | |
|---|---|-------------------------------------|
| White - RAL 9016 | Twilight Grey - Pantone 7544 | Tangerine - RAL 2009 |
| Painswick - RAL 7038 | Truffle Brown - Bespoke Colour | Golden Oak - Foiled Material |
| Rosewood - Foiled Material | Green - RAL 6009 | Pistachio - Bespoke Colour |
| Midnight Grey - RAL 2303010 | Anthracite Grey - RAL 7016 | French Grey - RAL 7001 |
| Forest Green - Bespoke Colour | Foiled White - RAL 9010 | Irish Oak - Foiled Material |
| Chartwell Green RAL 6021 (not a perfect match) | Buttercup - Bespoke Colour | Peacock Blue - BS381C103 |
| Blue - RAL 5011 | Duck Egg Blue British Standard Range 4800/5252 REF 20-C-33 | Ruby Red - RAL 3003 |
| Schwarzbraun - RAL 8022 | Black - RAL 9005 | |
| Cream - RAL 9001 | | |

Please note that all RAL colours are LAB matched and a slight difference in colour can occur.

If you are matching paint to one of our doors it is advised that you ask for a colour swatch.

Due to the limitations of the lithographic printing process, colours above may not be an exact match to actual doors.

A Colourful Entrance

Bringing you the latest trends right to your door

Premium Range

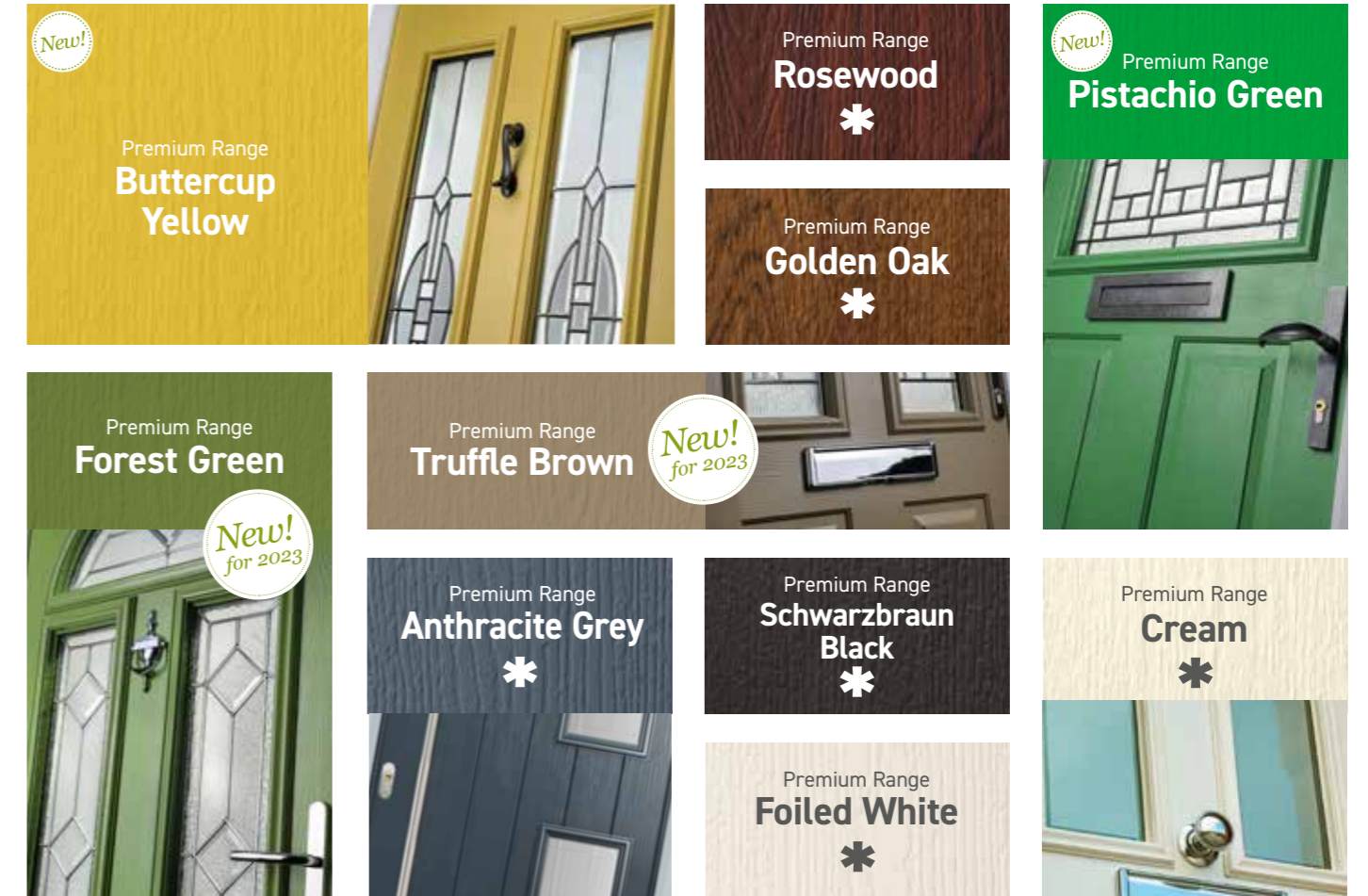

* Available as a door and / or a frame option ▲ Available as frame option for white internal only

Standard Range

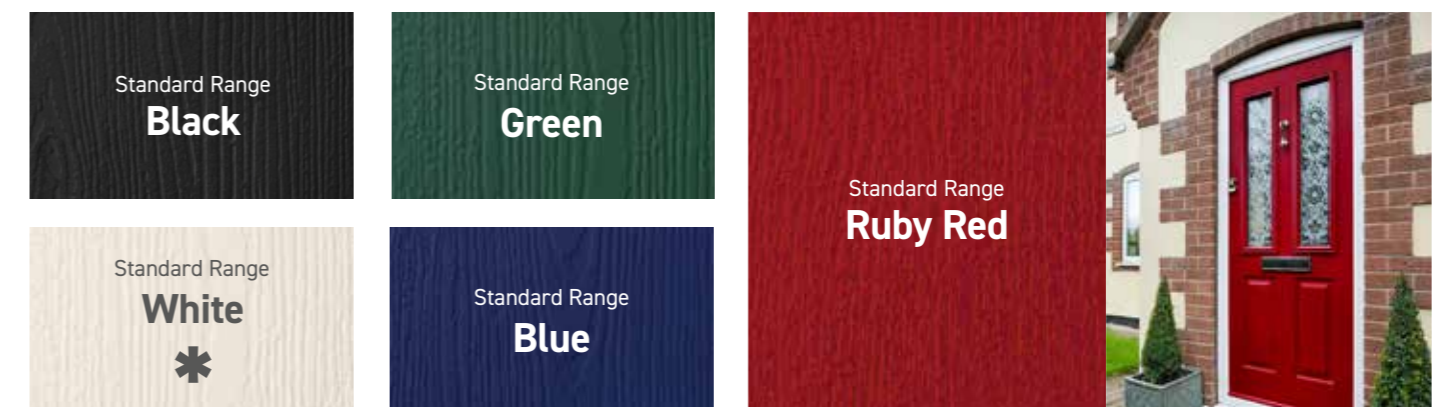

* Available as a door and / or a frame option

Frame colours will not be an exact match due to material differences

Sweet Hardware

Performs even better than it looks

A sweet combination of style and security.

Adding the finishing touches to your brand new door can make all the difference. Although, looks aren't everything. Your door's hardware should be every bit as reliable as the door itself.

All products in our Sweet hardware range come with a 20-year anti-corrosion guarantee for your added peace of mind. Plus, we only supply the 2-star lever handle - the highest possible Kitemark accreditation - with the 3-star encased Ultion cylinder, making this 5-star rated combination the most secure on the market.

Don't just take our word for it, with sold secure accreditation and a £2000 guarantee*, your home is in safe hands.



All available in a range of finishes: chrome, satin, gold, white, and black

The sleek and stylish registered curved design of the sweet handle means it not only looks good but makes it more difficult for an intruder to snap and access your home. Did you know that a standard handle can be removed in under a second, but this sweet handle is still protecting after two minutes!

Choose this sweet combination and design your dream Solidor today.



♦♦♦
£2000
GUARANTEE



Ultion £2000 Guarantee

If an intruder breaks into your home as a result of snapping your Ultion cylinder lock, Ultion will pay £2000.



THE Italia Collection

The Italia collection from Solidor is a new generation of truly contemporary designs which will add a touch of style to your home. Carefully designed and crafted from the finest materials, every door in the Italia collection has a definite style inspired by the Italian passion for design.

Each door is handmade in Staffordshire, ensuring the finished product is of an outstanding quality and made as individual as can be. Choose from a range of glass styles and door furniture which have been carefully chosen with the latest fashion and designs in mind. All of the doors in the Italia Collection are also available with Warwick Glass - hand made so no two pieces are ever the same.

Milano



Inspired by the greats of Italian design. The Milano is a luxurious addition to the Italia collection, offering a sophisticated, contemporary feel to any property.

The textured grain, linear design and off-set modernist glazing style, paired with contemporary accessories elevates the Milano as a door style which encompasses quality and aesthetic appeal.



Stippolyte

London Etch Border

Bullseye

Potomac

Colour - Black
ES3 1800 door handle and key only security locking option

Colours

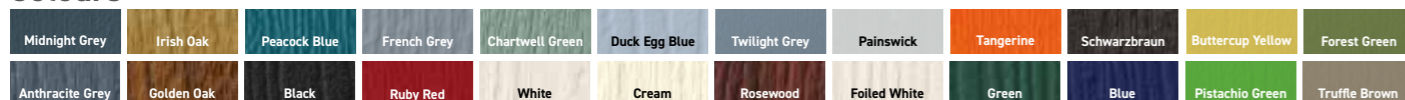

Palermo



Putting the Solid in this Solidor, choosing our Palermo design means opting for elite simplicity.

The Palermo's aesthetic is a stand out design for any home. We love our Palermo in a muted tone or traditional wood look, enhanced with one of our bar handles to achieve effortless sophistication that is bound to make any neighbour Solidor green with envy.



Colour - Golden Oak
ES3 1800 door handle

See the full range of glass options in our dedicated glass brochure at www.solidor.co.uk

Trieste

All Italia doors are available with or without grooves



Colour - Green
Glass - Dorchester

Rimini



Colour - Irish Oak
Handle- ES3 1800mm

Messina



Colour - Rosewood
Handle - ES3 800mm

Parma



Colour - Schwarzbraun
Handle - ES3 1800mm

Sorrento



Colour - Cream
Handle - ES3 400mm

Biella



Colour -Foiled White
Handle - Lever/Lever

Brescia



Colour -French Grey
Handle - ES3 1800mm

Ancona



Colour - Cream
Handle - EK53

Ancona Solid



Colour - Golden Oak
Handle - ES3 1800mm

Venice



Colour - Peacock Blue
Handle - ES3 1800mm

Garda



Colour -Painswick
Handle - ES24

Amalfi



Colour - Anthracite Grey
Handle - ES21

Colours

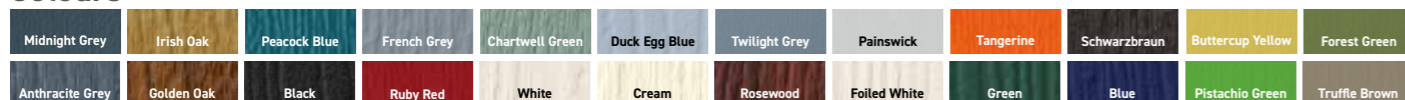

See the full range of glass options in our dedicated glass brochure at www.solidor.co.uk

Modena



Colour - Anthracite Grey
Handle - ES24

Genoa



Colour - Golden Oak
Handle - ES3 800mm

Siena



Colour - Blue
Handle - ES23

Monza



Colour - Blue
Handle - ES21

Verona



Colour - Duck Egg Blue
Handle - ES3 1800mm

Naples



Colour - Schwarzbraun
Handle - Lever/Lever

Pisa



Colour - Ruby Red
Handle - ES23

Bologna



Colour - Painswick
Handle - ES24

Roma



Colour - Tangerine
Handle - ES21

Turin



Colour - Chartwell Green
Handle - ES21



Colours

Midnight Grey	Irish Oak	Peacock Blue	French Grey	Chartwell Green	Duck Egg Blue	Twilight Grey	Painswick	Tangerine	Schwarzbraun	Buttercup Yellow	Forest Green
Anthracite Grey	Golden Oak	Black	Ruby Red	White	Cream	Rosewood	Foiled White	Green	Blue	Pistachio Green	Truffle Brown

See the full range of glass options in our dedicated glass brochure at www.solidor.co.uk

Italia Accessories

Designer handle range for our key only operated and slam shut auto locks

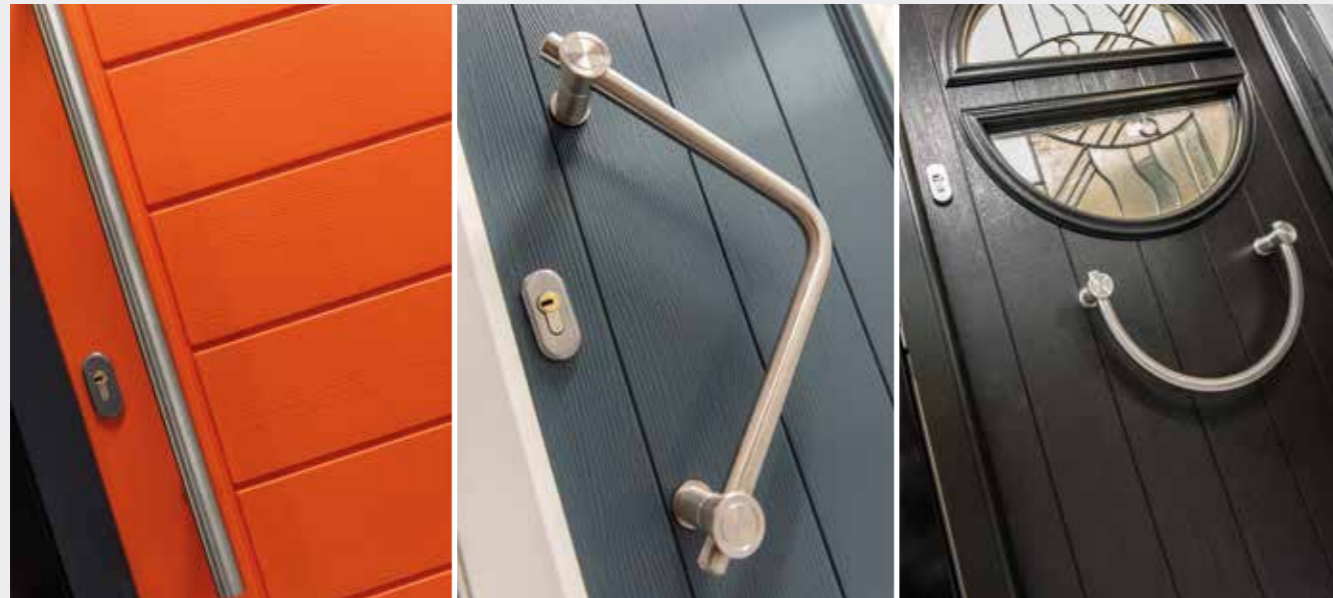

ES3 800mm

ES24

ES23



Bar handles will be at least 110mm from the edge of the door slab.

Pilkington Texture Glass Warwick™

This design is unique amongst our patterns because it is produced using a different manufacturing method. Pilkington Texture Glass Warwick™ is a random pattern that is added along the central portion of the pane and this has implications when cutting the glass down into finished sizes. It is possible, if a pane is small enough, it could be cut with no evidence of the pattern at all.

None of the Pilkington patterns are designed to have an orientation (an up side) but care needs to be taken with adjacent panes that the pattern direction is maintained. There is a linear nature to Pilkington Texture Glass Warwick™ and so householders should be aware that there could be aesthetic implications when choosing this design. Also, for the glass supplier the result may be that this pattern is less accommodating when cutting and may result in a greater proportion of seldge from the original glass plate.



Warwick Glass available in all of our Italia doors



Abstract Glass available in the Pisa, Turin and Siena



Satin Glass available in all of our doors



Ludlow



Colour - Painswick
Glass - London Etch

The Ludlow is Solidor's most popular style of composite door.

It's perfectly suited to both rich colours such as red and traditional woodgrain effects such as rosewood. The two glazed panels can help shape the visual appearance of the overall door with options ranging from the traditional diamond to the more contemporary abstract. There's also the option of a solid door, which looks great in Irish Oak.



The Victorian Caledonian Rose Dorchester Abstract



Simplicity Park Lane Bespoke Elegance Brilliance

Colours

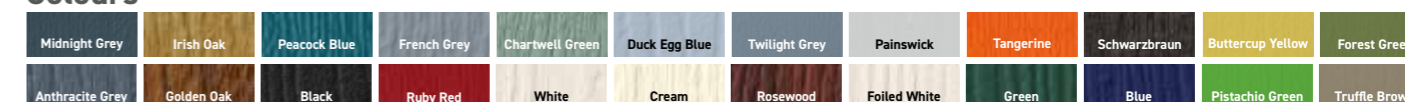

THE Traditional Collection

The Traditional collection from Solidor, brings classic designs into the modern era. Each door design is suited to both traditional and modern properties alike, and will add a touch of elegance to every home.

Conway

Beeston



Colour - Foiled White
Glass - Caledonian Rose

The Conway is a highly versatile composite door solution.

This door can be designed as a completely solid door, or with just the top fanlight glazed or even with a fully glazed design to take account of the vast array of glass options. The square or quad glass options can be manufactured in grey, black and red colours for added elegance. Our advice is to also choose a bold door knocker for this design!

The Beeston makes a fantastic composite stable door.

Given the size of the glazed area, it's possible to create something particularly individual when combined with one of the major colours, or you can even specify an integral blind. Like all the doors in the Solidor range, there's the option of chrome, brushed, gold, black chrome, black and white door furniture. So go on, be bold in your design!

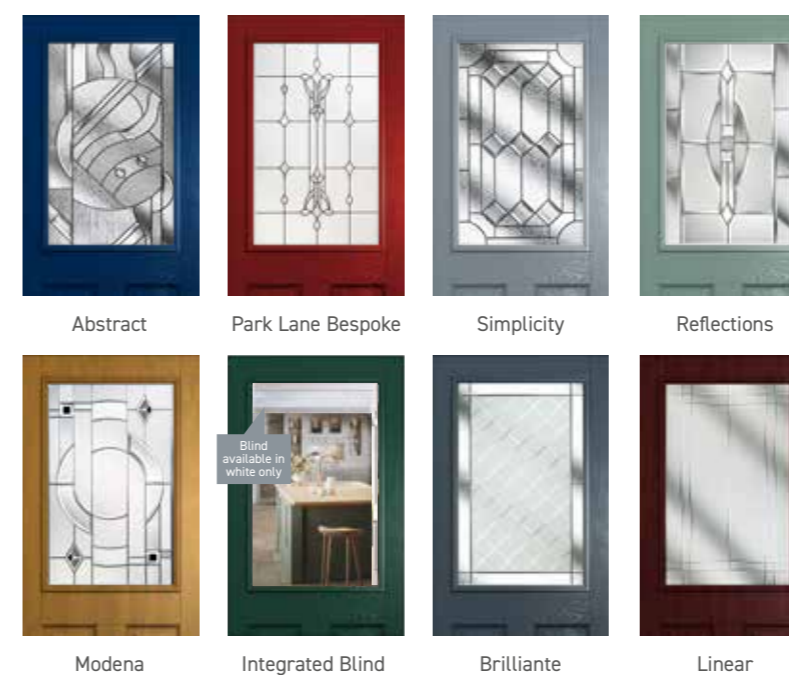
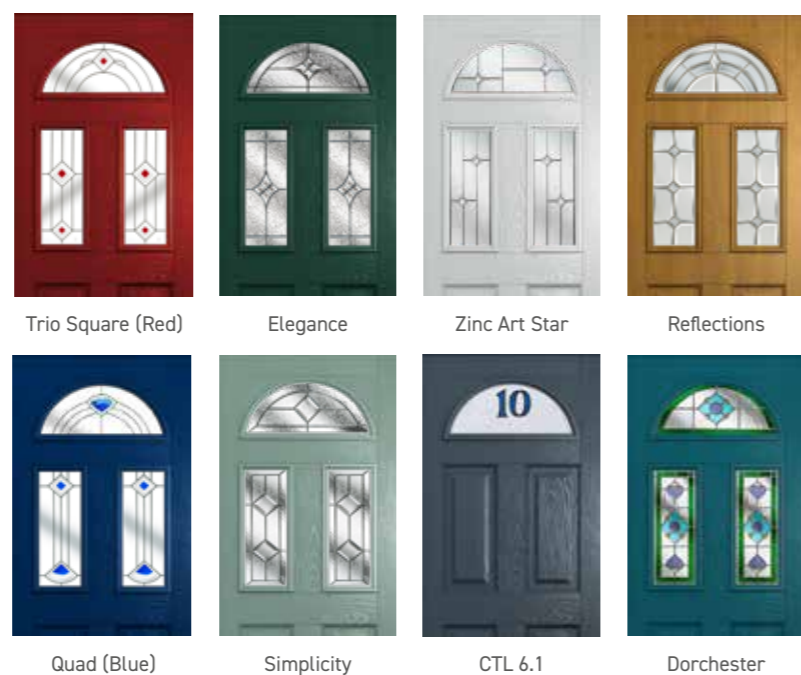

Colour - Black
Glass - Elegance

Colours

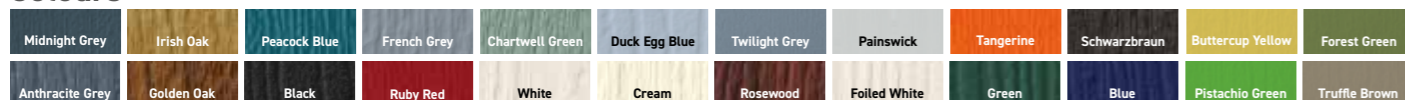

See the full range of glass options in our dedicated glass brochure at www.solidor.co.uk

Stirling



Colour - Duck Egg Blue
Glass - Oceanic
Handle - Lever/Lever

London



Colour - Golden Oak
Glass - Dorchester

Berkeley



Colour - Duck Egg Blue
Glass - Dorchester

Harlech



Colour - Green
Glass - Jewel

Stafford



Colour - French Grey
Glass - Royale

Thornbury



Colour - Schwarzbraun

Edinburgh

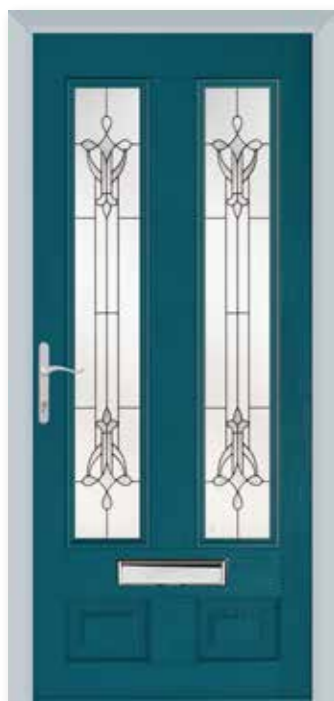

Colour - Peacock Blue
Glass - Park Lane Bespoke

Alnwick



Colour - Chartwell Green
Glass - Modena

Nottingham



Colour - Schwarzbraun
Glass - CTB19.2

Tenby 2



Colour - Peacock Blue
Glass - Reflections

Tenby 4



Colour - Painswick
Glass - Quad (Grey)

Windsor



Colour - Anthracite Grey

Windsor Solid



Colour - Irish Oak

Colours

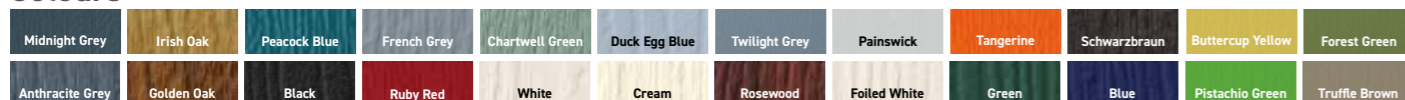

See the full range of glass options in our dedicated glass brochure at www.solidor.co.uk

The Flint Collection



Flint 1
Colour - Blue
Glass - Square (Green)

Doors from the Flint Cottage Range are the perfect fit for British cottages.

It's fast becoming the number one choice for homeowners with cottages, farmhouses or for those looking for a side door option, thanks to its vertical panelled appearance. We have also added a contemporary twist to the design with the introduction of single or triple diamond shaped glass features to broaden its appearance. It's also proving a great option as a stable door.



Square (Butterscotch)

Square (Sea Green)

Satin

Stippolyte

Star Clear

Star Black

London Etch

Bullseye

Colours

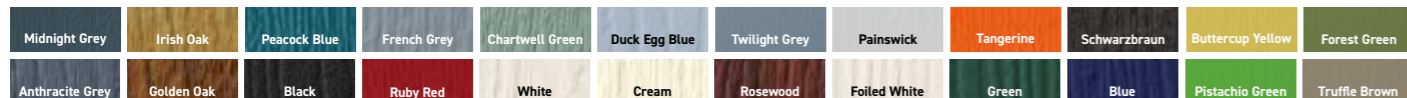

Flint Solid



Colour - Duck Egg Blue

Flint Square



Colour - Ruby Red
Glass - Bullseye

Flint Beeston



Colour - Midnight Grey
Glass - Square Lead

Flint 2



Colour - Cream
Glass - CTB 18.1

Flint 3



Colour - Chartwell Green
Glass - Trio Square Green

Flint 4



Colour - Golden Oak
Glass - Diamond Lead

Flint 5



Colour - Painswick
Glass - Modena

See the full range of glass options in our dedicated glass brochure at www.solidor.co.uk



IDEA

Use wall spaces to display an alternative classic letterbox, in a style to complement your door.

TIP: Make a statement and frame the doorway with a walled path for a truly grand entrance!

Classic

British design

Ludlow

With a truly natural looking woodgrain effect, our classic British door designs are *timeless*.

Achieve an authentic Victorian look with the Ludlow, fast becoming **Britain's most popular door.**

With simple clean lines, the Ludlow has the power to create either a modern or a traditional entrance for your home. Available as a solid door for added privacy, or with two glazed panels, the Ludlow combines classic Victorian design with modern materials. Either option will create a polished and sophisticated entry.

▼ *Lighten it up*

Open up your front entry with glazed panels on both sides of your door. They will flood your hallway with light, make your entry seem larger, and enhance your home's architectural style.



◀ *All in the detail*

Our elegantly shaped handles and accessories in sleek chrome suit this Ludlow perfectly.

Visit www.solidor.co.uk/accessories to view our range of hardware



▲ *Back to basics*

Keep it simple by adding ornate planters either side of the door or a hard wearing welcome mat - enough to complete the subtle look in smaller spaces.



Which Colour?

Choose Schwarzbraun with stained glass and traditional door furniture to retain the door's original Victorian charm, or give it a contemporary edge by opting for French Grey with polished chrome accessories.

Choose your colour from our new and updated range on page 8 >>

Schwarzbraun

French Grey

French Doors



All of our designs, in all of our colours are available in a French Door option, with a range of handle options, encompassing a high security, adjustable, multipoint locking system.



Available as inward or outward opening doors. Because our French door range is so vast, please contact us for the minimum and maximum sizes before you order your set.

NOTE: Available with UPVC and aluminium threshold on inward opening sets, and UPVC only on outward opening sets.



Flush, integrated two way lever, which throws the shootbolts and removes the need for a lever handle and cylinder to give the option to use our Italia Collection handles on both leaves, alternatively, go for lever operated!

Standard option is both doors to be lever handle operated.

Stable Doors

Did you know that the majority of our Traditional Collection and a selection of our Italia Collection door styles can be available as (open in only) stable doors? With the choice of any colour from our range available on any side, contact us for more details today!

Solidor[®]
EXCLUSIVE

Secured by Design



Police Preferred Specification



All of our stable doors come with a high security, fully adjustable multi-point locking system. They are also keyed alike, benefit from an internal thumb turn cylinder on the top and bottom half and have a latching security bolt as standard.



Side Panels



Complement your property with a full range of matching full height and half side panels.
 (contact us for details on the full range of side panels available)



Half Moulded

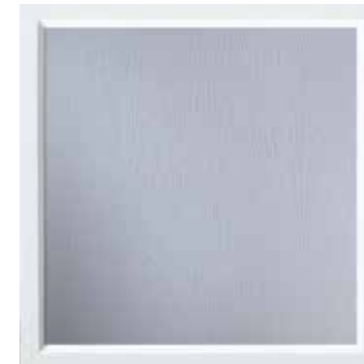

Half Flat Grain



Quarter Moulded



Milano Side Panel



Milano



Brescia



Thornbury



Ludlow



Harlech



Available in all of our colour options!

Tenby

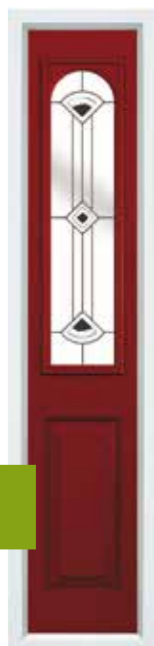

Nottingham

New!

New colours for
Spring
2023



We offer the **largest** range of colours from stock in the UK.

Choose from 24 colours for the inside and / or the outside of your door. You also have 9 frame colour options to choose from. When selecting your colour from this guide please be aware we advise you to ask for a colour swatch to check both colour and grain structure.

What's New For 2023



Truffle Brown

If your customers are looking for more muted neutrals such as taupe and beige, Truffle Brown will hit the spot. With its subtle cool tone, this colour won't go out of style and acts as the perfect accent for traditional homes.

Forest Green

When your customer wants the fun of an energetic front door but doesn't want to make too much of a statement, Forest Green could be just the trick. A versatile colour that suits both urban and rural properties, homeowners can get back to nature with this tranquil shade.

Pistachio Green

Customers are going to go nuts for Pistachio Green! Symbolising cleanliness, new beginnings and harmony, homes will feel revived with this statement green. The vibrant colour will liven up any space, making it a sure winner with design-conscious homeowners.

Buttercup Yellow

If being subtle isn't in the brief, the vibrant Buttercup might be right up their street. Known to evoke feelings of positivity and happiness, this yellow door can bring a little sunshine all year round.

Furniture & Accessories

A selection of beautiful accessories and high security locks to perfectly complement your choice of door. Whether contemporary or traditional, you will find an accessory to really make your door stand out.

Door Knockers

Doctor



Premium 7" Doctor



Urn

Available with or without spyhole



Pony Tail



Stainless Steel



Lion

Not available on Tenby 4, Conway 3, Ludlow, Edinburgh, Harlech or Nottingham

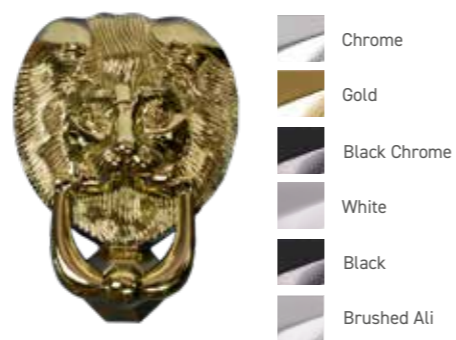

Viewer



Letterplates



The Architectural Range

Knocker



Lever / Lever inline handle

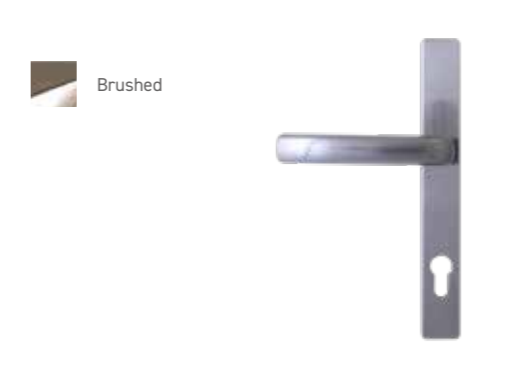

Letterplate (Opens inwards)

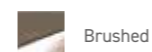

The Classical Range

Bullring Knocker



Lever / Lever inline handle



Pull Knob







Letterplate (opens inwards)



Butt Hinge











-  Gold
-  White
-  Black
-  Silver

Hinges

Our new slimline, PAS 24 tested, face fixed flag hinge is sleek and modern. Available for open in doors only.







- | | |
|--|---|
|  Chrome |  White |
|  Gold |  Black |
|  Brushed |  Antique Black |
|  Black Chrome |  Black |
| |  Pewter |

Extra Security





Security Door Guard



- | | |
|---|---|
|  Chrome |  White |
|  Gold |  Black |
|  Brushed | |

Stable Door Latch Suited where possible







- | | |
|--|---|
|  Chrome |  Brushed |
|  Gold |  Black |

Handles

A large range of premium quality handles to complement our doors. Available with a choice of a standard lever or one of the three exclusive options across the whole range of finishes.







Swan Hardex



-  Chrome
-  Gold
-  Brushed
-  Black Chrome
-  Antique Black







Lever Hardex



-  Chrome
-  Gold
-  Brushed
-  Black Chrome
-  White
-  Black
-  Antique Black

Lever Pad





-  Chrome
-  Gold
-  Brushed
-  Black Chrome
-  White
-  Black
-  Antique Black

Ironmongery

We have a range of stunning traditional knockers and handles that add a real touch of class.



Traditional Avon Slimline



-  Black
-  Pewter



Traditional Monkey Tail



-  Black
-  Pewter



Traditional Cottage



-  Black
-  Pewter



Door Knob



-  Chrome
-  Brushed

Trojan Letterplates

Stainless steel specifically for coastal properties

-  Chrome
-  Brushed
-  Gold

Standard



TS008 SBD Only (White internal)



Trojan Urn

Stainless steel specifically for coastal properties





-  Gold
-  Chrome
-  Brushed



Trojan Handles

Stainless steel specifically for coastal properties





-  Gold
-  Chrome
-  Brushed



Traditional Pull Knob





-  Pewter
-  Black

Teardrop Knocker

Not available on Tenby 4, Conway 3, Ludlow, Edinburgh, Harlech or Nottingham





-  Pewter
-  Black

Handmade Ring

Not available on Tenby 4, Conway 3, Ludlow, Edinburgh, Harlech or Nottingham





-  Pewter
-  Black

Traditional Letterplate

Letterplate for illustrative purposes only
Opens inwards











-  Pewter
-  Black

Finger pulls

Available with the heritage lock



- | | |
|--|---|
|  Chrome |  Black Chrome |
|  Gold |  White |
|  Satin |  Black |
|  Pewter |  Antique Black |
|  Black | |

The Sweet Range

Sweet Handles



Sweet Knockers

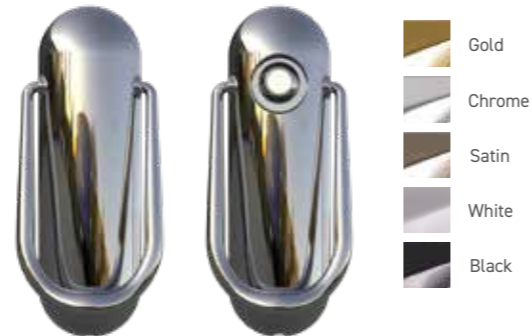

Sweet Letter Plates



Sweet Numerals



Finishing Options

OUTER FRAME OPTIONS

Which frame would you like? Choose from Kömmerling Chamfered C70 or Sculptured O70 outer frame.



EDGE BANDING COLOURS

White as standard, brown on Rosewood / Walnut, Anthracite Grey on Schwarzbraun, Black, and Anthracite Grey when coloured both sides, caramel on Golden Oak and Irish Oak when coloured both sides. For all other dual colour combination white edge band is use.



Thresholds

To allow for every circumstance we offer the largest range of door thresholds. The AM3 and AM5EX aluminium threshold are both Part 'M' compliant within the latest Building Regulations for easy access.

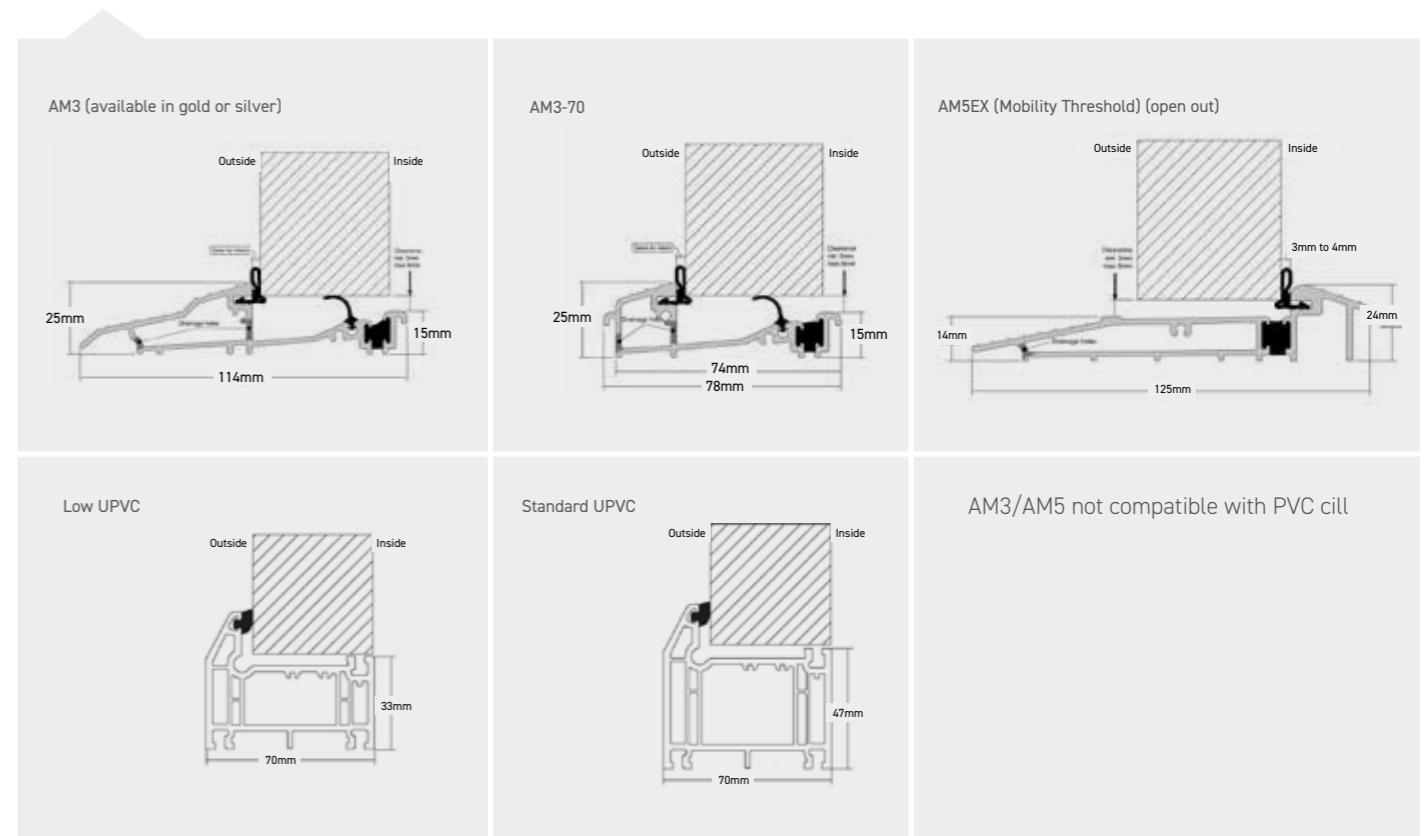

Solidor[®]
EXCLUSIVE

Artistic Glass



Inspired by classical artistic styles, such as art deco, minimalism, and the impressionist movement, The Modernist Range of glass is unique to Solidor.

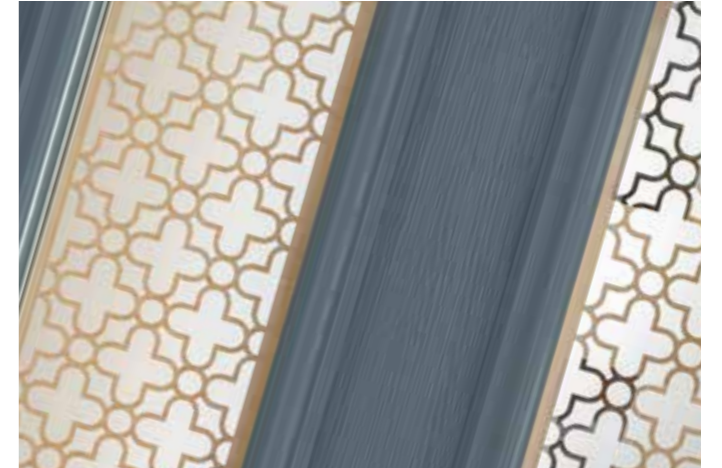

Fairmont



Paramount



Wiltern



Gaumont



Tate

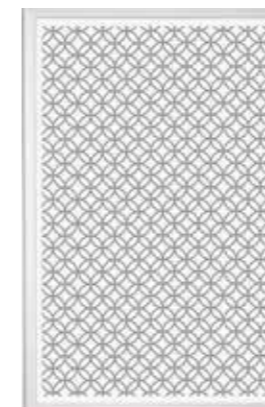

Fairmont



Paramount

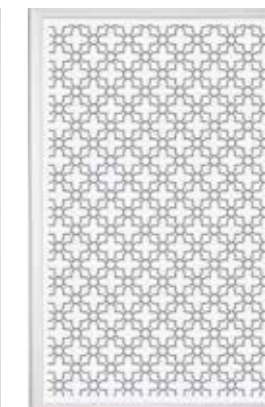

Wiltern



Tate

Traditional Range Backing glass required

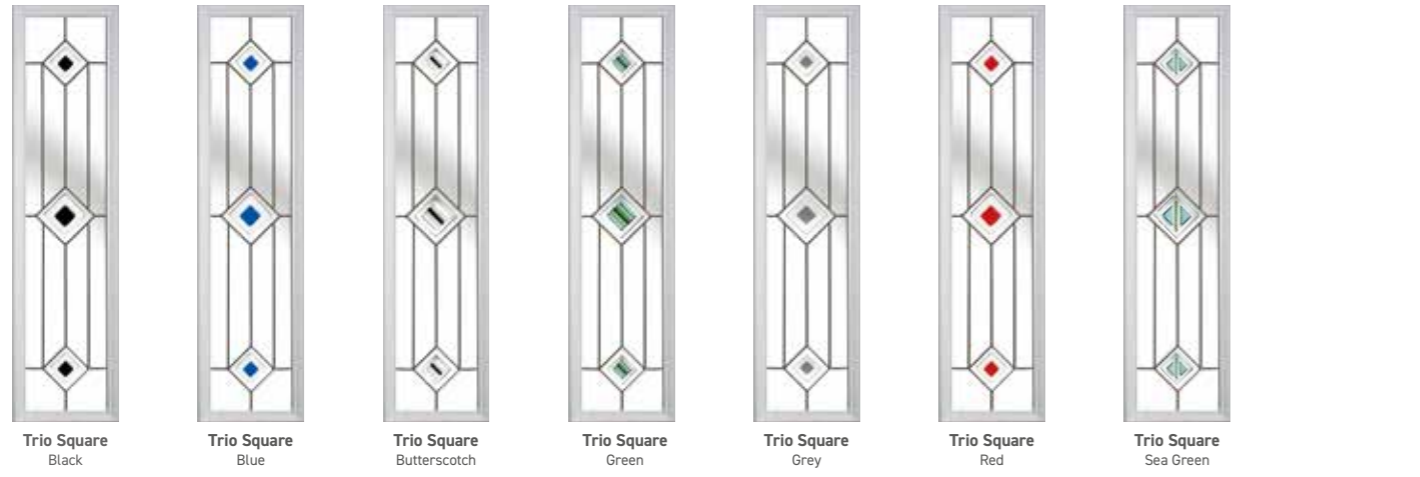

Trio Square Black, Trio Square Blue, Trio Square Butterscotch, Trio Square Green, Trio Square Grey, Trio Square Red, Trio Square Sea Green

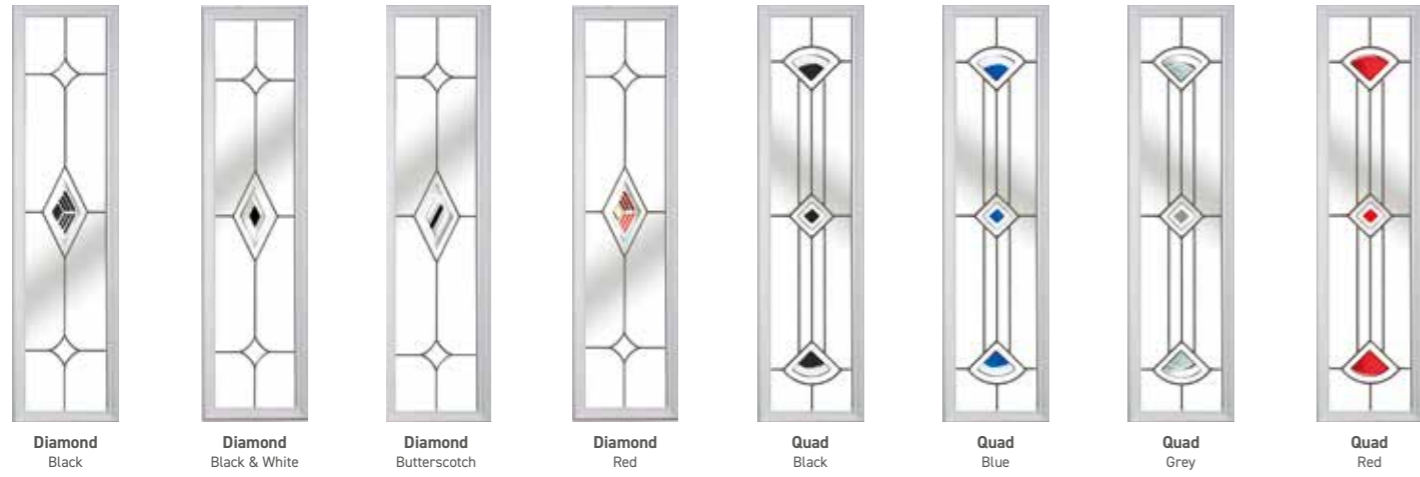

Diamond Black, Diamond Black & White, Diamond Butterscotch, Diamond Red, Quad Black, Quad Blue, Quad Grey, Quad Red



CSB 5.1FT



CGB-F
Cassette only not internal glass



CTL 6.1

Available in white only



Open Blind
Clear glass only



Closed Blind



CTB 12.3
Clear bevels available



CTB 18.1

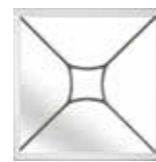

Star Clear



Star Black



Bullseye

Decorative Glass Backing glass not optional.



Matrix, Modena End result dependent on door style, Park Lane Bespoke, Victorian, Zinc Art Star, Caledonian Rose Handed, Dorchester, Etched Squares



Linear, London Etch Border, Abstract, Brilliance, Clarity - GOLD, Elegance, Simplicity, Potomac



Prairie, Reflections, Royale



CFT 2.1, CTB 17.2, CTB 19.2, CTL 31.2B

Design your dream door

Choose a door style and request a quotation from an approved installer.

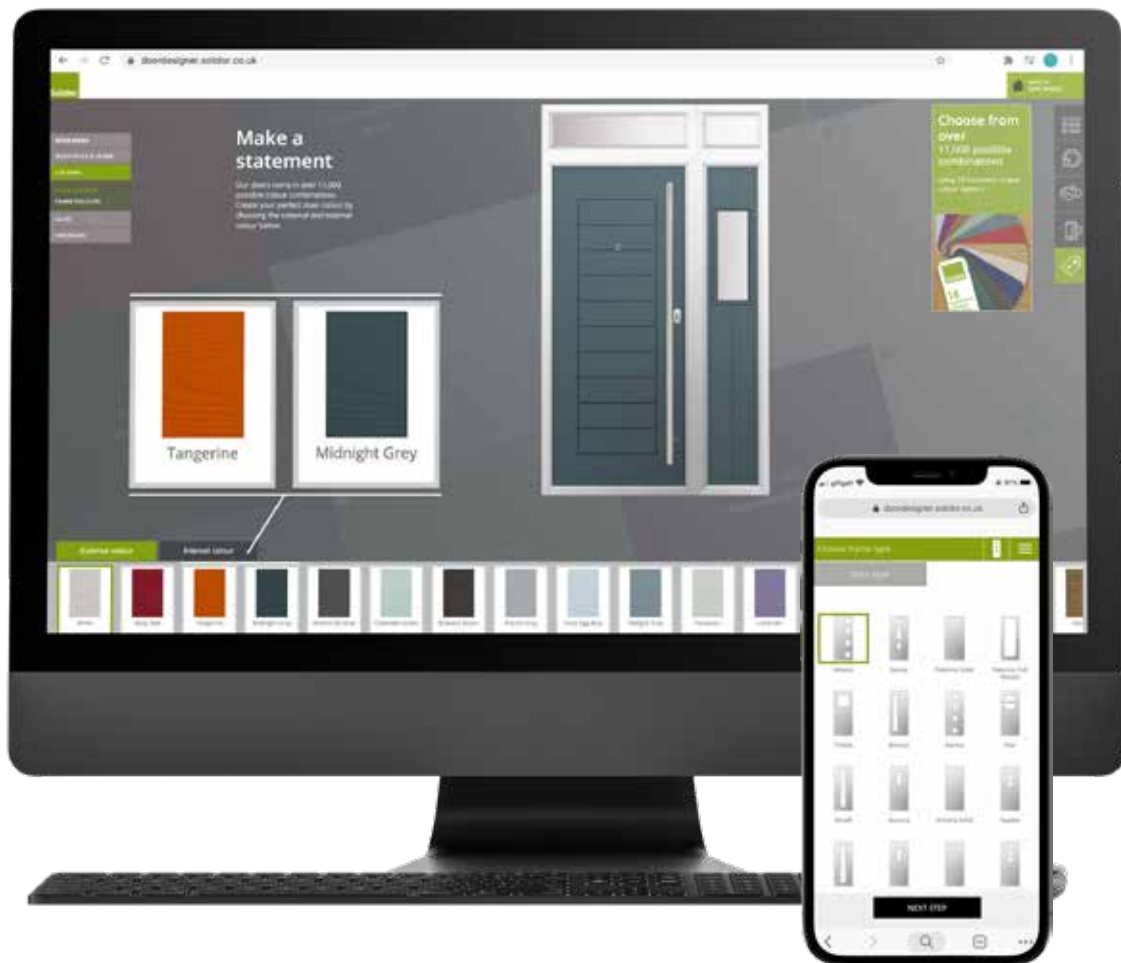

To create your perfect Solidor go online

doordesigner.solidor.co.uk



Edition 22

