

# G | M | B

GOODMAN MANN BROOMHALL  
CHARTERED SURVEYORS

## DESIGN ACCESS & HERITAGE STATEMENT

9-15 HIGH STREET SUTTON SM1 1DF



GOODMAN MANN BROOMHALL  
CHARTERED SURVEYORS  
118 PICCADILLY,  
LONDON, W1J 7NW

Date: 28th February 2024  
Revision A

## **1.0 Site Analysis**

9-15 High Street, Sutton is a four storey Building (including basement) located on the corner of High Street and Grove Road that was constructed in the early 1930's. It is formed with part pitched, part flat roof, solid brick walls and wood double hung sash windows in the main. The ground floor elevations are formed as shop fronts to the Nando's and Zizzi Restaurants.

The upper parts is prominently residential with office accommodation occupying approximately 20% of the area. The ground floor & basement are used as restaurant premises.

## **2.0 Heritage significance**

Mitre House is described in the Sutton Town Centre Conservation Area Appraisal as follows:

Mitre House sits prominently at the junction of High Street (Nos. 9 to 15) and Grove Road (1 to 7), embracing its corner status in both name and form. It is classical in its proportions, with a three-storey structure wrapping around the corner, before dropping to two storeys. Neoclassical features include stone decoration along the main fascia, with triangular pediments above central and corner bays, and a sculpted bishop's mitre at the corner. Original nine-over-nine sash windows to the first floor, dropping to six-over-six at the second. The building has a hipped roof, brick quoins, bonded flat brick arches with keystones, and a pronounced cornice.

## **3.0 Objectives & Justification**

The applicant proposes to replace the 1<sup>st</sup> and 2<sup>nd</sup> floor wood double hung sash windows on the High Street and Grove Road elevations, along with the two remaining wood sash windows on the rear elevation.

The existing window are in poor repair, dating from the original construction of the building in the mid 20<sup>th</sup> century. They are single glazed and draughty, offering poor insulation and energy efficiency. Their condition is shown in the photographs in Section 5 below.

It is proposed to replace the windows with white Conservation-style uPVC double glazed units to a matching double hung sash design to the High Street, Grove Road and rear elevations (where indicated), with glazing bars to mimic the present arrangement.

#### **4.0 Design and Appearance**

The High Street, Grove Road and rear double hung sash windows will be replaced with the Bygone Symphony range as manufactured by Masterframe. They will incorporate:

- Wood grain foil
- Putty line appearance
- Bespoke Bygone furniture
- Continuous horns
- Slim integral mullion for multi-light windows
- Deep bottom rail
- 39mm 'Super Slim' meeting rail
- Super slim 10mm vacuum insulated FINEO glazing
- Timber look cill

The appearance of the Conservation style windows and relevant cross-sections are shown in Appendix 1 attached to this document.

#### **5.0 Impact Assessment**

The proposed works are intended to replace existing windows in poor condition with energy efficient glazing to reduce the carbon footprint for the residents and reduce energy bills.



The windows will be to the same colour and design as existing and of a Conservation Style that has been approved in numerous Conservation Area applications nationwide.

There will be minimal impact to the heritage asset as the new windows are of a Conservation design and the immediately adjacent buildings have been retro fitted with uPVC windows.

#### **6.0 Access and Sustainability**

There are no proposals that affect these matters.

## 7.0 Photographs

1	Location: External Elevations  Description:  Typical window condition	
2	Location : External Elevations  Description:  Typical window condition	
3	Location: External Elevations  Description:  Typical window condition	



4. High Street Elevation



5. Grove Road Elevation



6. Rear Elevation



7. Rear Elevation



8. High Street Streetscene – showing adjacent PVC windows



9. Grove Road Streetscene – showing adjacent PVC windows

## **APPENDIX 1**

**Masterframe Bygone Symphony Range brochure**

**Bygone Symphony Range cross sections**



# Bygone Symphony (2019) Cross Sections

## Vertical Cross Section

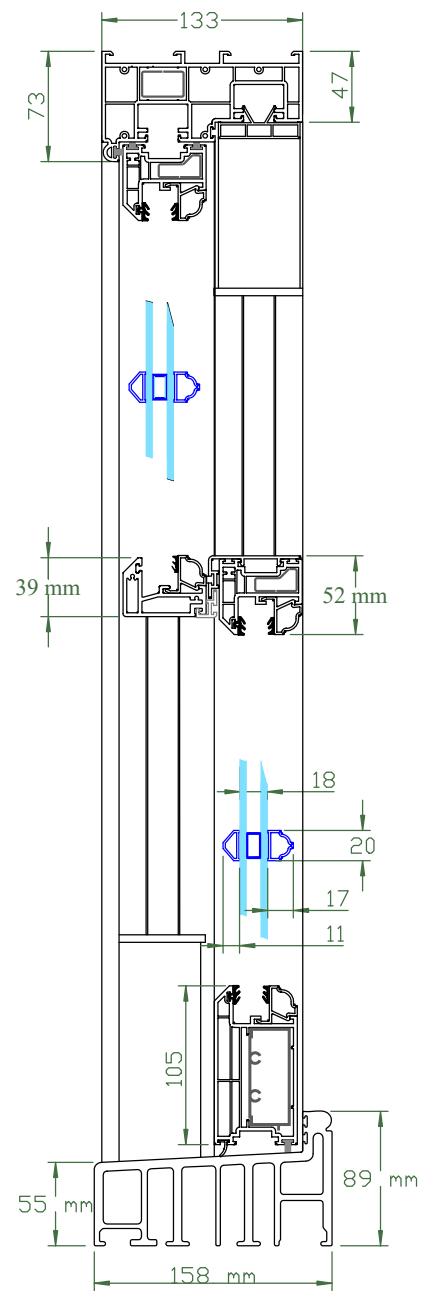

## Horizontal Cross Sections

### Bottom Sash

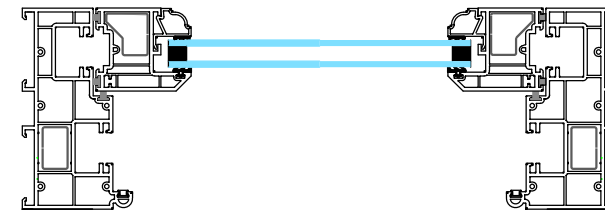

### Top Sash

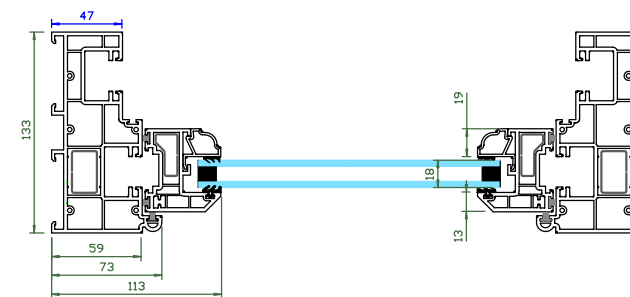

**masterframe**  
 4 Crittall Road  
 Witham  
 Essex  
 CM8 3DR  
 01376 510410  
 www.masterframe.co.uk  
 Registered in England: 2272659

**Copyright Notice**  
 The contents of this drawing are the copyright and Intellectual Property of Masterframe Windows Ltd. The detail of the drawing may be confidential information. Dissemination and reproduction is not allowed without prior express permission of Masterframe Windows Ltd.

Title: Bygone Symphony 2019			
Original Drawing date: 26 - 03 - 2019			
Drawn By: R Rabett			
Revision History			
REV	Amendment	BY	Date
DO NOT SCALE: Dimensions in mm.		DWG Reference: G:\Masterframe\Technical\CE_Mark\DOP\2019\Bygone Symphony 2019	

BYGONE  
COLLECTION



SASH WINDOWS



---

# Bygone Collection

## The very best sash windows

The Bygone collection is designed to satisfy the requirements of modern windows, in line with current building regulations. However, our first requirement is for the windows to blend seamlessly into their surroundings; retaining the character, charm and period feel of your home.

To ensure you'll have beautiful windows, we've taken the time to study original sash windows and recreate critically important details like these;

- Slim sight-lines through both sashes maximises the visible glass area.
- Equal panes in both sashes creates a balanced appearance consistent with original timber sash windows.
- External staff bead detail on the frame and an option for internal staff bead trims, to conceal the inner workings of the window, just like old sash window boxes.
- Continuous run-through sash horns to resemble those utilised by the Victorians. Designed to place more material below the mortise, therefore strengthening the stile.
- Patented Timberweld® technology creates a butt-jointed appearance on Bygone windows that look every part their timber, mortise and tenon, counterparts.
- A durable grained acrylic foil, designed to look like painted timber, creates a stunning finish. So convincing is the effect that one town planner, building his own home, did not believe a Bygone window was not timber.
- Original sash windows are often found as twin or tripartite windows, built together in timber. The Bygone slim integral mullion replicates this perfectly, creating a beautiful, traditional, multi-light window.
- An elegant deeper cill section is available for those installations that aim to replace a deep timber cill, traditionally sat on stone or tile.

12  
YEAR  
GUARANTEE

# Bygone Collection sash windows - authentic details

We're totally committed to creating authentic sash windows, with the proportions and elegance of the originals, but with all the attributes demanded by modern living.

## Timberweld® technology

Timberweld® was developed to create joints that are beautiful and authentic, looking every bit like a timber original and giving the impression that it has been lovingly produced by a master craftsman.

Most butt joints in the market today are open ended, however Timberweld® joints are completely sealed from the elements with no open chambers to allow in rain water, draughts, or insects!

The manufacturers of the Bygone Collection, Masterframe Windows Ltd., are the only sash window manufacturer licensed to use Timberweld® technology.



## 'Super slim' 39mm meeting rail

Original period sash windows were traditionally made with timber, a material with very different strengths. For years manufacturers have been trying to replicate the timber aesthetics of traditional sash windows but have failed to reproduce the slim profiles, until now.

The Bygone Symphony has an industry first for PVC-U sash windows by introducing a super slim mid-rail measuring just 39mm (1 1/2"), as seen on so many Georgian properties. In order to preserve the slim sight lines when using the 39mm mid-rail, the internal mid-rail is also reduced from 62mm to 52mm. The super slim mid-rail is available on Harmony and Symphony windows only.



## Integral 99mm slim mullion

The visible mullion between windows in some cases can be as wide as 250mm, which is nothing like the slim mullions on original timber windows.

The Bygone Collection introduced an industry first by producing a bespoke mullion measuring just 99mm across the front face, substantially reducing the overall sight-lines. When combined with Timberweld® construction, Bygone windows look superb and unlike any other multi-light window on the market. If you require the 'coupled' style of window, this remains available in certain cases.



## Thin sealed units

Air filled insulated sealed units were once 28mm, but with gas filled units we have been able to reduce the depth to 24mm or even 18mm. Slimmer double-glazed units allow for deeper glazing beads and deeper Georgian bars, improving the aesthetics of the sash.

Exclusive 10mm FINEO vacuum insulated glazing is now available on the Symphony range. FINEO is a pioneering new breed of glazing, delivering astonishing thermal performance, impressive noise reduction and unprecedented sustainability (see page 9 for further details).



## Continuous or 'Run-Through' Horns

Traditionally, decorative sash horns were a Victorian design, engineered to add strength to the top sash. Today sash horns are still needed to retain the traditional appearance of your box sash windows. Unlike decorative, "clip on" horns which can become detached, look artificial and have a tendency to fade in colour, all Bygone sash horns are sculpted from the sash itself. Commonly known as "run through" or "continuous" horns", they have a recessed flush fitting end cap for a tidy finish.

---

### Deep Bottom Rail

Traditionally, the lower rail of the bottom sash was made from 4” or 5” timbers and planed to about 100mm. This was substantially heavier (deeper) than the other sides of the sash, as it had to carry more weight than the upper sash. All Bygone collection windows have this butt jointed deep bottom rail as standard.



### Authentic Georgian Bars

Bygone chamfered and ovolo Georgian bars are face fixed, authentically recreating the depth and shadow lines of original timber muntin bars. External bars are always chamfered, but internal ovolo bars on a Bygone window come in three depths depending on the range and the depth of the glass unit.

All Bygone windows use a patented method of interlocking and securing bars to the glass with our patented Georgi® Clip, so bars are guaranteed to stay firmly attached for the life of glass unit.

The method is approved by the BBA and means that Bygone Georgian bars are included in the Bygone 12 year guarantee.



### Chamfered 'Putty-Line' Sashes

Original sash windows had putty glazing which sloped back to the glass at an angle of 45 degrees. This lovely putty-line is included on the outside of every Bygone collection window for this very reason.

Internally our glazing beads are by contrast ovolo shaped, just like original Victorian and Georgian sash windows.



---

### Bygone Bespoke Limit Stops

Limit stops prevent a window from opening beyond 100mm, particularly useful for bedrooms or ground floor windows

Bygone collection limit stops have been designed to sit flush in the surface of the sash and are securely screwed into the steel reinforcement. This reduces wear on brush piles and prevents draughts for years to come.



### Foam Cill Pads

Rain water will exploit any weakness in the fabric of a building, and the joints of a sash window are no exception. Bygone windows have an innovative foam pad of our own design, for sealing the joints between cill and frame.

The foam cill pads prevent any chance of water ingress, often seen on other sash window designs and we cut back the cill brush piles to prevent water being drawn into the frame cavity. For peace of mind, we add a final silicone seal for good measure.



### Internal Staff Bead Trim

An exclusive feature on Bygone windows is a unique internal trim, developed to hide the channel on the inside of the window where the frame meets the sashes. This internal staff bead trim, replicates the aesthetics of a traditional timber box, giving Bygone windows a truly authentic look.

The trim is mounted on a hinge and held in place magnetically, allowing it to open and close when the sashes are tilted in for cleaning.





---

# FINEO, the new generation of insulating glass

To conserve energy and reduce heating bills, Symphony Sash Windows now come with 10mm FINEO vacuum-insulating glass, and an insulation value of 1.2U, similar to triple-glazed windows, but only a fraction of the thickness.

Using a new glass technology consisting of two panes of glass separated by a vacuum gap, FINEO out-performs double or even triple glazing;

- FINEO offers the same thermal performance as triple glazing, while being 3 to 4 times thinner. Thanks to FINEO, the heat stays inside your building, making it more comfortable without increasing your heating bill.
- FINEO vacuum glazing lets in 15% more natural light than triple glazing. This means you can enjoy more light in your home.
- Soundproofing a home is key to the wellbeing of the occupants. Significantly reducing external noise pollution is possible thanks to FINEO, which offers some of the best sash window soundproofing on the market.
- Symphony Sash Windows fitted with FINEO have a U-value of 1.2 making it the market leader in thermal efficiency on timber-alternative sash windows. Peace of mind for those looking to stay warm and save energy, with period style and authenticity.

- The materials used for FINEO - vacuum insulating glazing are environmentally friendly, lead-free and 100% recyclable.
- Due to the state of the art materials and production techniques FINEO outlasts traditional glazing units, so much so we can offer a guarantee of 15 years on the units.

15  
YEAR  
GUARANTEE



---

# Your choice of 3 beautiful ranges

If like us, you believe the box sash style of window remains the most beautiful window of all time, you'll appreciate our elegant yet pioneering designs.

Faithfully reproducing traditional features like chamfered putty line sashes, staff beads, slim meeting rails, and butt joints, places Bygone windows in a league of their own. Upon closer inspection, we are sure they will exceed your expectations.

We understand that every home improver has a budget, that's why we've packaged three options for you. Whilst we apply the same care and dedication to each range, we have simplified some of the timber features on the Bygone Melody, making it the most affordable of our ranges.

For those requiring every feature available, the Symphony comes with everything as standard, whilst Harmony offers a similar slim line appearance to Symphony, but with conventional double glazing.

We are certain that you will be very happy with the aesthetics, thermal efficiency and peace of mind you will receive, regardless of which Bygone window you finally choose.

In the following pages you will find more detail on Melody, Harmony and Symphony and there's a comparison table on page 26.



Our policy is one of continued product development, therefore we reserve the right to change product designs without notice, or withdraw certain options. Our Master Installers will make you aware of such changes.



# Bygone Melody

Created using the same core components as Harmony and Symphony, the Melody sash window offers outstanding value.



- Unique 12 year guarantee
- A Rated for energy efficiency as standard
- Secured by Design as standard – a police approved accreditation for complete peace of mind
- Manufactured in the UK using components sourced in the UK
- Patented Timberweld® technology
- Wood grain foil
- Exclusive putty line appearance
- Bespoke Bygone furniture in a range of colours
- Continuous horns
- Slim integral mullion for multi-light windows
- Deep bottom rail
- Standard 52mm meeting rail
- 24mm double glazing
- Two integral cill options
- High grade Torso II balances tested to at least 25,000 cycles – an average life expectancy of 34 years\*
- Patented design features

\*Based on opening and closing the windows twice a day





# Bygone Harmony

The addition of a slim meeting-rail makes Harmony a truly convincing timber alternative sash window.



- Unique 12 year guarantee
- A Rated for energy efficiency as standard
- Secured by Design as standard – a police approved accreditation for complete peace of mind
- Manufactured in the UK using components sourced in the UK
- Butt jointed construction
- Patented Timberweld® technology
- Wood grain foil
- Exclusive putty line appearance
- Bespoke Bygone furniture in a range of colours
- Continuous horns
- Slim integral mullion for multi-light windows
- Deep bottom rail
- 39mm super-slim mid-rail
- 24mm double glazing
- Two integral cill options
- High grade Torso II balances tested to at least 25,000 cycles – an average life expectancy of 34 years \*
- Patented design features

\* Based on opening and closing the windows twice a day



# Bygone Symphony

When it absolutely must look like timber because the planning officer is insisting or simply when only the very best will do, there is only one choice.



- Unique 15 year guarantee
- A Rated for energy efficiency as standard
- Secured by Design as standard – a police approved accreditation for complete peace of mind
- Manufactured in the UK using components sourced in the UK
- Wood grain foil
- Exclusive putty line appearance
- Bespoke Bygone furniture in a range of colours
- Continuous horns
- Slim integral mullion for multi-light windows as standard
- Deep bottom rail or large butt jointed bottom rail
- 39mm ‘Super Slim’ meeting rail
- Super slim 10mm vacuum insulated FINEO glazing
- Exclusive timber look 158mm cill or standard 147mm is also available
- High grade Torso II balances tested to at least 25,000 cycles – an average life expectancy of 34 years \*
- Patented design features

\* Based on opening and closing the windows twice a day

---

# Bespoke locks, restrictors and furniture

The Bygone Collection offers a range of beautifully designed window furniture that does not compromise on security.

Our design team looked at hundreds of standard cam catches, ranging from thin zinc alloy imports, to chunky industrial locking systems that lack finesse. Having helped write the UK's first security standard for sash windows, we knew the structural loads and requirements needed, but also understood the primary features had to be beautiful and traditional.

Over hundreds of years there have been regional variations on sash window furniture. So we've extended our range to offer you something that suits your property and your individual taste.

Bygone windows come with two distinctive furniture options; Beehive, or Acorn. Either option is available in Champagne Gold, Satin Chrome, Polished Bronze or Polished Chrome.

Each cam catch comes complete with its own Allen key and you'll find all Bygone window furniture, including limit stops, pole eyes and handles, suites perfectly to ensure a colour match on all components across each window.



---

No sash window is complete without a traditional handle set, even if some homeowners do insist on using the Georgian bars.

Traditionally, scroll handles or cups were fitted on windows internally and D handles under the top sash were fitted externally. Most homeowners prefer something visually appealing that can be reached easily from the inside.

All Bygone furniture is colour suited and manufactured by the same hardware company, therefore you will find all the components match and you certainly won't find an assortment of odd colours.

All Bygone windows come with two scroll handles, a single ring pull for the upper sash or two pole eyes depending on vent position. Don't worry, we also offer bespoke oak handled poles to reach the ring pull.

Scroll handles and pole eyes are always supplied loose because some clients prefer to specify exactly where they should be fitted.





# Unique styles & shapes

Our sash windows can be manufactured in a variety of styles and shapes, allowing you to match your existing window design.

Bygone windows offer most Georgian bar designs and even some less traditional ones. We can also replicate specific visible glass sizes or line Georgian bars and mullions up with existing windows and doors.

Whilst single sliders are common place, coupled or multi-lights are regularly requested. Remember the slim integral mullion reduces sight-lines by more than 50mm.

We are often asked to make windows with arched heads of varying degrees. Whilst a 'true arch' will have a full semi-circular head, a shallow arch or 'swept head' will have a much shallower radius. In the case of 'true arches' the top sash will always need to be fixed and will not slide.

Occasionally, our installers are asked to supply windows that are square on the inside, with a swept head on the frame outside. Even these are possible and they're simply known as 'The London sash and frame'.

We appreciate that your home is likely to be your single biggest investment and for this reason we really don't mind you obsessing over the finer details, in fact we encourage it!

If you have something particularly complicated, we can provide technical drawings to help you visualise the final design. Always feel free to discuss any unusual design features with your Master Installer, they will be happy to help.

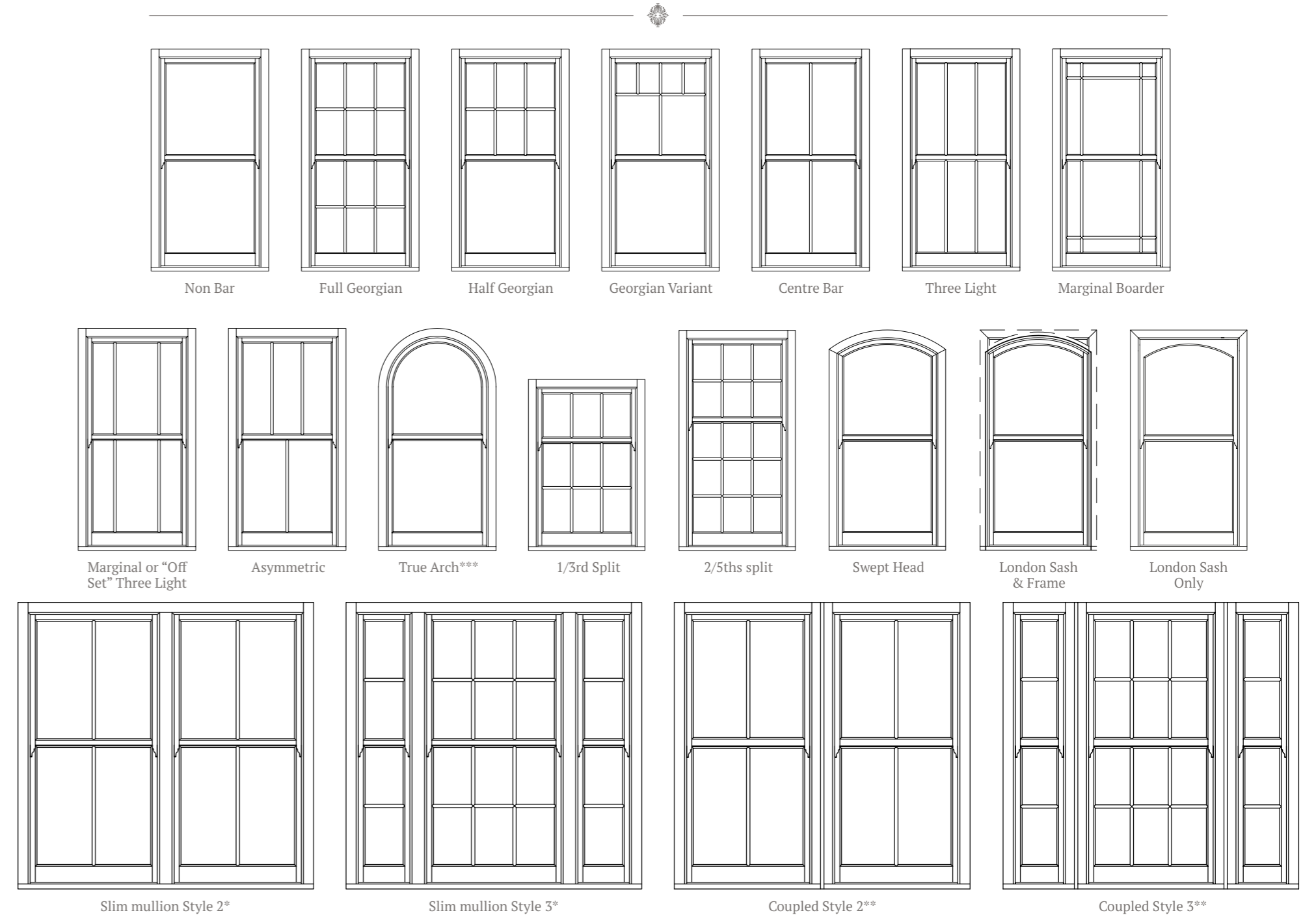

All windows depicted show mechanical butt jointed construction and slim mid rail (representative of Bygone Symphony). \*available on Harmony and Symphony only \*\*available on Melody only \*\*\*not available with FINEO glass



# Colour options

**There was a time in the evolution of timber alternative windows that everything was a flat white, PVC-u finish. As technology has moved on and times have changed, there are now exciting colour possibilities available.**

Acrylic foil was originally added to PVC-U windows as protection against damaging UV rays and over exposure to the elements.

Once PVC-U itself became UV neutral, the possibility of adding colour to the foil proved an exciting proposition.

Fast forward a few years and we now have windows with a grained appearance, in any number of colour matched paint options.

Colours are available from the standard industry charts such as the RAL colour chart and various other popular branded charts. We can even colour match to your favourite shades from paint houses such as Sanderson or Farrow & Ball.

All our colour matched acrylic paint finishes have an added hardener and come lacquered as standard ensuring they perform to our high standards, whether coastal, inland or inner city.

The Bygone Collection has two standard foil options, white and antique cream; your bespoke colour can then be applied to your chosen foil. Make sure you ask your Master Installer for a colour swatch and prospective prices.



## A touch of colour

Many modern products come in a variety of colours, but the box sash window, synonymous with period properties all over the UK, traditionally had a white painted finish.

This limits the demand for colours on the Bygone Collection, but with geographic colour trends and the introduction of colour options on various market leading door and casement products, unusual colours are becoming more popular.

The standard Bygone white wood grain finish is an off-white and can be colour matched to RAL number 9010, much as our Antique Cream can be matched to RAL number 9001.

## Colour coatings

Typically we spray entire windows, however we can offer different colours externally to internally and different combinations from sash to frame. A black frame with white sashes is a traditional combination, seen all over the UK, but we have also sprayed combinations of blue and white or cream and maroon.

When the outside of the window is a different colour to the inside, we spray all visible surfaces to the desired colour, so only one colour is visible from either side when the window is in the closed position.

Our two-part chemical cured paint is far harder wearing than water based paint, as we believe durability is paramount. Standard household decorator's paints should never be used for painting PVC-U.

## Environmental considerations

In marine or coastal environments, salt corrosion must also be considered. We apply a durable clear lacquer on all paint finishes, regardless of exposure, to ensure that the risk of any visible signs of aging is virtually nil.

## Colour guarantees

We are so confident in our paint and the process followed, after having it independently tested we put our reputation behind the product and extended our 12 year guarantee to include any colour sprayed finish as well.

## Ancillary colour matching

A key to any good installation is having the whole package done correctly. Bygone will spray any decorative trim required by the installation company, to ensure that the finished installation colour matches perfectly.

## Extended lead times on coloured products

Please remember that sprayed windows do take longer to produce than our standard colour options. We prefer to offer a sample of the colour prior to commencing production, and the spray process does take time. It is likely our standard lead time will be extended by at least two weeks.

\* Please remember that whilst we offer as close a match as possible to a number of colour charts from major paint suppliers, we use a high performance, spray applied colour coating, especially designed for products within the window and door industry. There is also the possibility of slight shade differences between batches of the same colour.



# Glass

Glazing is one of the most important aspects of any window. It can be transparent or opaque, stained or coloured and can even showcase geographical patterns and fashion trends.

Glass can say a lot about a window, which in turn can tell you a lot about the property and its history. Traditionally, large panes of glass meant wealth, due to the complicated nature of glass production in the 17th Century. Smaller panes were often saved for shop fronts and included bulls eyes, the centre of the spun glass and the cheapest to produce.

Stained glass and overly complicated Georgian bar designs were similarly a sign of wealth in Victorian Britain and there are examples of this all over the country, but especially in larger cities .

Aged lead occurs less in sash windows, but is still occasionally seen, making for a heavier window and can often have a negative impact on thermal efficiency.

Glazing itself has had to change with the times and other qualities are now more important to the modern home owner. These include acoustics, thermal efficiency, security and durability, often dictated by ever evolving building regulations and planning laws.

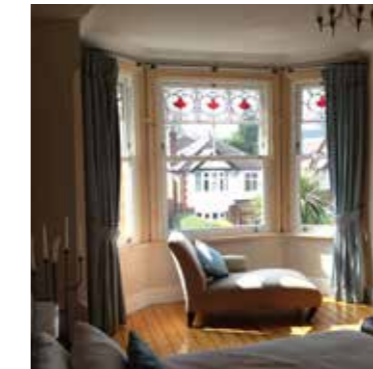

# Bygone comparison table



Standard Specification			
Timberweld® butt-jointed construction	✓	✓	✓
Super-Slim 39mm mid-rail	X	✓	✓
Slim 50mm mid-rail	✓	X	X
Slim integral mullion	✓	✓	✓
Continuous run through sash horns	✓	✓	✓
Deep bottom rail	✓	✓	✓
Integral cill	✓	✓	✓
White woodgrain foil finish	✓	✓	✓
24mm argon filled double glazing with 1.5U-value	✓	✓	X
10mm FINEO vacuum insulating glazing with 1.2U-value	X	X	✓
Standard internal ovolo glazing bead	✓	✓	X
Exclusive deep internal ovolo glazing bead	X	X	✓
Beehive or Acorn furniture (Champagne Gold, Polished Chrome, Satin Chrome or Polished Bronze)	✓	✓	✓
Scroll handles	✓	✓	✓
High grade torso balance springs	✓	✓	✓

Key: ✓ - Available X - Not Available



Chargeable Options			
Antique cream woodgrain foil finish	✓	✓	✓
Painted colour matching	✓	✓	✓
Textured obscure patterned glass	✓	✓	✓*
Sandblasted, satin, etched or patterned glass	✓	✓	X
Toughened, acoustic or laminated glass	✓	✓	✓
Victorian single vertical bar	✓	✓	✓
Bespoke Georgian bar design	✓	✓	✓
Trickle vents	✓	✓	✓
Exclusive frame vent concealer	✓	✓	✓
Projecting cill - 85mm, 120mm, 150mm, 180mm or 225mm	✓	✓	✓
Internal Staff Bead Trim	✓	✓	✓
Arched or shaped heads	✓	✓	✓**
London sash	✓	✓	✓
London sash and frame	✓	✓	✓
GRP deep cill	✓	✓	✓

Our policy is one of continued product development, therefore we reserve the right to change product designs without notice, or withdraw certain options. Our Master Installers will make you aware of such changes.

\* Only available in film format on FINEO glass \*\* If using FINEO glass then no shapes or arches in TXG

# Choosing the right installer is as important as selecting the right sash window

You can ensure your windows are the best that money can buy, but many don't consider that even a top quality window won't perform correctly if poorly installed.

**masterframe**  
**MASTER INSTALLER**  
QUALITY AND EXCELLENCE

Sash windows are finely tuned products and benefit from professional installation to ensure perfect operation, appearance and long term performance.

For example, a beautiful Bygone Collection sash window can be indistinguishable from a timber window even to the most critical eye. However, if your new sash window is installed into the existing box frame, it will not sit in the correct position.

### Consequently...

- It will look bulky because too much frame will be exposed.
- Solar gain will be significantly reduced.
- Aesthetically, the kerb appeal of your home will be affected.

The method of fixing and the fitting tolerances always need to be considered, as sash windows require much more attention than other styles. Professional installation will ensure positive outcomes against draughts, water penetration and noise pollution.

Some home owners prefer maintenance free plastic reveals and window boards, others prefer a painted timber surround. There are a number of finishes possible, even lifting your existing Victorian architraves and re-using them or having replacements copied to match those being removed.

Bygone windows can be finished with any number of modern PVC-U or foiled trims that are now available within the industry, for a more contemporary look.

All this requires an experienced, trained professional to give advice on how to blend new windows into the existing fabric of a building so as to go unnoticed. This is why we will not allow anyone other than authorised, Master Installers, to install Bygone windows.

Ask your Master Installer to show you a sample and talk through how the installation will be performed and managed. They will be happy to advise you of the best way to achieve the look you desire and the finish your home deserves.



---

# 12 **YEAR** GUARANTEE Guarantees - for your peace of mind

With a wealth of experience, over **35** years, of building high quality sash windows and after over **25** years of the Bygone Collection, rest assured that we offer excellent after sales service with a guarantee that counts for something.

When using one of our Master Installers we promise to:

- Deal with any issue quickly and without fuss using our dedicated Customer Service Team.
- In the unlikely event that the Master Installer ceases to trade during, or before completing your installation, we will appoint an approved partner to oversee the remainder of the contract.
- If the above proves impossible we will forward any deposit that you have paid us via the installer, directly to another window company of your choice, so you are fully protected no matter what happens.

This is a double guarantee, but only available via authorised Bygone Master Installers. Please check that your appointed installer appears on our list of approved companies, by visiting our website [www.masterframe.co.uk](http://www.masterframe.co.uk), entering your postcode and following the instructions on screen to find your nearest Bygone Master Installer.



E&OE \*all information contained is understood to be correct at time of writing



## Glossary

### Acorn design

A bespoke Bygone furniture design, shaped like an acorn.

### Acrylic wood grain foil

An acrylic covering on Bygone windows with a wood grain textured finish.

### Anodised

An anti-corrosive coating applied to aluminium components.

### Architrave

Timber or PVC-U moulding used around windows to make good internally.

### Argon gas

A particular type of gas found inside some sealed glass units that increases thermal efficiency.

### Article 4 directive

An additional restriction applied to conservation properties requiring development right and compulsory planning permission.

### Astragal bar

The traditional Victorian glazing bar found on sash windows.

### Balance retaining clips

Exclusive clips that prevent balance springs becoming detached from sashes.

### BBA

The British Board of Agrément third party product testing.

### Beehive design

A bespoke Bygone furniture design, shaped like a beehive.

### BFRC

British Fenestration Rating Council.

### Box Sash

Another name for a sash window - originates because the sashes were traditionally housed within a timber box containing the sash weights and pulleys.

### Brush pile

The draught-excluder or wool pile around the sashes to prevent air leakage.

### Brush seal

See brush pile.

### BSI

British Standards Institute.

### Butt joints

The vertical corner joint traditionally found on timber windows.

### Cam catch & keep

The two parts of the locking mechanism found on the mid-rail on the inside of a window often referred to as a fitch catch.

### Chamfered

The angled moulding resembling a traditionally ‘putty-lined’ timber window, found on the external Georgian bar and sash profile on the window exterior.

### Cill pads

A specially designed foam pad, creating a weather tight seal between integral cill and frame jamb.

### Conservation area

An area that may be considered of historical or cultural importance to the local authority.

### Continuous run-through horns

A decorative continuation of the stiles, incorporating a mechanical butt joint on the bottom of upper the sash.

### Deep bottom rail (DBR)

A deep bottom rail on the lower sash, incorporating a mechanical ‘butt’ joint to strengthen the bottom sash.

### Deep cill

A deeper cill section that measures 55mm in height and 158mm front to back, constructed from GRP.

### DGU

‘Double glazed unit’ is a term for a sealed glass unit consisting of two panes of glass and a central cavity, often containing a particular gas.

### Double glazed

When two panes of glass are used instead of one.

### Dummy sashes

Sashes within a window that are deliberately fixed and do not slide.

### Etched glass

Patterned glass where the pattern is etched into the glass rather than textured or obscured.

### Existing box frame

The original timber box that housed the sash weights and pulleys.

### Face-fixed bars

Astragal bars that are fixed to the outside of the glass both internally and externally to recreate the impression of timber glazing bars.

### Fenestration

The arrangement of windows on a building.

### FENSA

Fenestration Self-Assessment Scheme. A competent person scheme for window and door installers.

### FINEO

A market leading light-weight vacuum insulated glazing for improved performance.

### Finger Latch

The mechanism operated by a tilt knob that allows the sash to be disengaged from the frame for the ‘tilt to clean’ facility.

### Foam baffles

A foam square applied above the tilt rest guides, preventing air penetration through the balance chambers.

### Frame profile

The outside frame member.

### Frame vent

A trickle vent fitted to the frame head on a window - see trickle vent.

### Georgi®Clips

A small patented metal clip that fits around a glass unit and under the glazing bead to securely attach astragal glazing bars.

### GGF

The Glass and Glazing Federation, an industry trade federation.

### Glazing bead

The beading around the inside edge of a sash, holding the glass unit in place.

### Krypton Gas

The dense gas used within an 18mm ‘slim’ sealed glass unit.

### Grade I and II listed

A heritage rating given to properties of historical significance, stipulating planning permission to protect their appearance.

### GRP

Glass reinforced plastic, used for added strength in Bygone window construction.

### Handed cams

When two Bygone cam catches are required on a window they are paired LH and RH for symmetry and security.

### Head rail

The top bar of the sash or frame.

### Infill strip

A patented PVC-U insert that replaces the brush-pile on the inside of a window.

### Integral mullion

An exclusive slim mullion section, used on double or triple windows made in one frame section.

### Internal Staff Bead Trim

This trim replicates a sash box on the inside of the window, hiding the join between sash and frame. Internal staff bead trim is mounted on a hinge and held in place magnetically, allowing the sashes to tilt when cleaning is required.

### Jambs

The industry term for the sides of a window.

### Krypton Gas

The dense gas used within an 18mm ‘slim’ sealed glass unit.

### Laminated glass

Two pieces of glass bonded together with an acrylic interlayer.

### ‘Lift out’ pivot bars

Metal bars, designed to allow sash removal for maintenance, ease of access and escape.

### Limit stops

A recessed item of furniture applied to the top sash that limits the opening of the window(usually 100mm) when engaged.

### London Sash & Frame

A sash window design with the appearance of a curved head externally, but a rectangular head internally.

### Low E

The ‘Low Emissivity’ coating normally applied to the inside pane within the cavity of a double glazed sealed glass unit to achieve better thermal efficiency.

### Low iron

Glass with low iron content is used on the outside pane of some double glazed sealed glass units to increase clarity and maximise solar gain.

### Master Installer

A window installation company that is a member of the Bygone preferred installer network.

### Meeting rail

Also known as a mid-rail or transom, this is the rail running across the window, where the top and bottom sashes meet.

### Mullion

The dividing section on multi-light windows or is a term also used to describe the brick piers on Victorian or Georgian, Bay windows.

### Multi-lights

Window frames made up of two or three windows in a row, also referred to as a style 2 or style 3.

### Mullion

The dividing section on multi-light windows or is a term also used to describe the brick piers on Victorian or Georgian, Bay windows.

### Muntin bar

See Astragal bar.

### Obscured glass

Patterned, textured or opaque glazing to obscure transparency and often used in bathroom windows.

### Ovolo

Also referred to as Ogee, this is the moulding found on the Georgian bar and glazing bead on the inside of Bygone windows.

### PAS24

A published product standard for enhanced fenestration security previously known as BS7950 that sets a standard for enhanced window security.

### Pole eyes

A circular bracket fixed to the top of the window so a pole hook can be used to lower the tops sash when out of reach.

### Pole hook

A wooden pole with a metal hook on one end for lowering a top sash when out of reach and a pole eye is fitted.

### Pre-tensioned

Balance springs that can be used immediately from the factory, without any adjustment required.

### Putty line

The term used to describe the chamfered appearance of the sash frame where it meets the glazing. This is due to putty traditionally being used when glazing timber windows.

### PVC-U

Polyvinylchloride – Unplasticised.

### Safety arms

A more durable stay, employed when sashes are too heavy to be safely held by tilt rests; - see tilt rests.

### Safe T Stays

See safety arms.

### Sand blasted glass

Clear glass blasted with grains of sand at high pressure to achieve a semi-opaque appearance.

### Sash lifts

A pair of small curved handles fitted to the bottom of the lower sash on the inside allowing the sash to be opened.

### Sash profile

The design of the sash and the term used for the individual length of PVC-U used for the window sashes.

### Sash stop

A section of PVC-U covers profile, cut to a particular length and covered with a cap that limits the range of the sash to prevent over extending the balances.

### Sash vent

A trickle vent fitted to the sash head on a window - see trickle vent.

### Satin glass

Semi-opaque glass with a similar appearance to sandblasted with a smoother finish.

### Scroll handles

See Sash lifts.

### Sealed unit

See DGU.

### Springing line

On a window with a curved head, this is the distance between the apex and the shoulder (start of the curve) of the window.

### Swept head

A window with a curved head, but with a shallower radius than a true arch.

### Tilt rests

A metal arm housed in the frame and connected to the sash that holds in position when tilted inwards for cleaning.

### Timberweld®

This name is a registered Trade Mark that describes a unique method of creating timber style butt joints that carries a Duchy Investments Ltd patent.

### Torso balance

Bespoke balance springs, calibrated for each individual sash and selected for their durability and longevity.

### Travel restrictors

See limit stops.

### Trickle vent

A two part component, consisting of internal vent and external vent hood to promote secure air flow when the window is closed.

### True arch

A window with a curved head and springing line of half the width, creating a semicircular arched head.

### Ultra-lift balance

A type of spring balance with a twisted metal rod housed within a spring. Particularly durable, these spring balances also produce an ultra smooth action.

### UV neutral

Unaffected when exposed to ultra-violet light.

### U-value

The calculation often used to denote the thermal efficiency of a window when considering heat loss.

### Weights & pulleys

The sash cord and lead weights found in original timber box sash windows that allowed the windows to be held unassisted in the open or closed position.

### Welded mitred joint

This is the angled joint on the frame and sash of a PVC-U window. These joints are mitred at an angle of 45 degrees using a welder.

### WER

‘Window energy rating’ calculated using the solar gain against heat lost registered with BFRC.

### Window board

The internal timber cill fitted underneath a window on the inside.



**Tel:** 0800 0484 671

**Email:** [hello@bygonecollection.co.uk](mailto:hello@bygonecollection.co.uk)

**Office:** 4 Critall Road, Witham, Essex CM8 3DR

**[www.masterframe.co.uk](http://www.masterframe.co.uk)**