

IT IS THE CLIENTS AND/OR PRINCIPAL CONTRACTORS RESPONSIBILITY TO ENSURE ASBESTOS IS IDENTIFIED. SIDEY DESIGN WILL ASSUME THE ROLE OF "PRINCIPAL DESIGNER" THROUGH PRE-CONSTRUCTION PHASE UNDER CDM REGULATIONS. UNLESS CONTRACTED TO DO SO, SIDEY DESIGN WILL NOT ACT AS THE "PRINCIPAL CONTRACTOR". ALL DIMENSIONS TO BE CHECKED ON SITE. ANY DISCREPANCIES TO BE RAISED WITH SIDEY DESIGN ASSOCIATES BEFORE WORK COMMENCES. DO NOT SCALE EXCEPT FOR THE PURPOSES OF PLANNING. THIS DRAWING IS TO BE READ IN CONJUNCTION WITH STRUCTURAL ENGINEERS INFORMATION AND CALCULATIONS. SIDEY DESIGN ASSOCIATES ARE A PROUD MEMBER OF THE CHARTERED INSTITUTE OF ARCHITECTURAL TECHNOLOGISTS

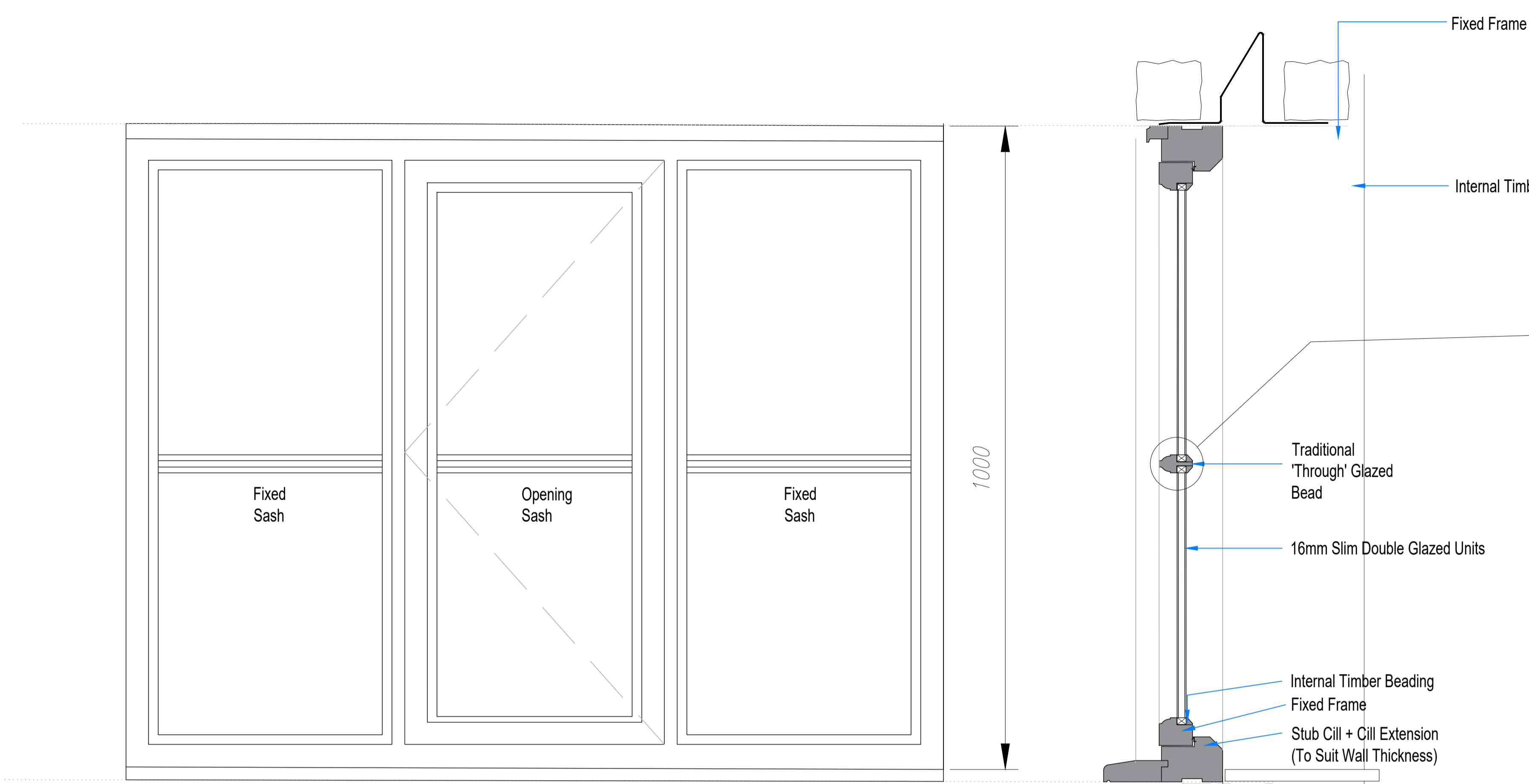

Proposed Glazing Bar Detail Scale 1:5

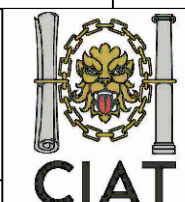
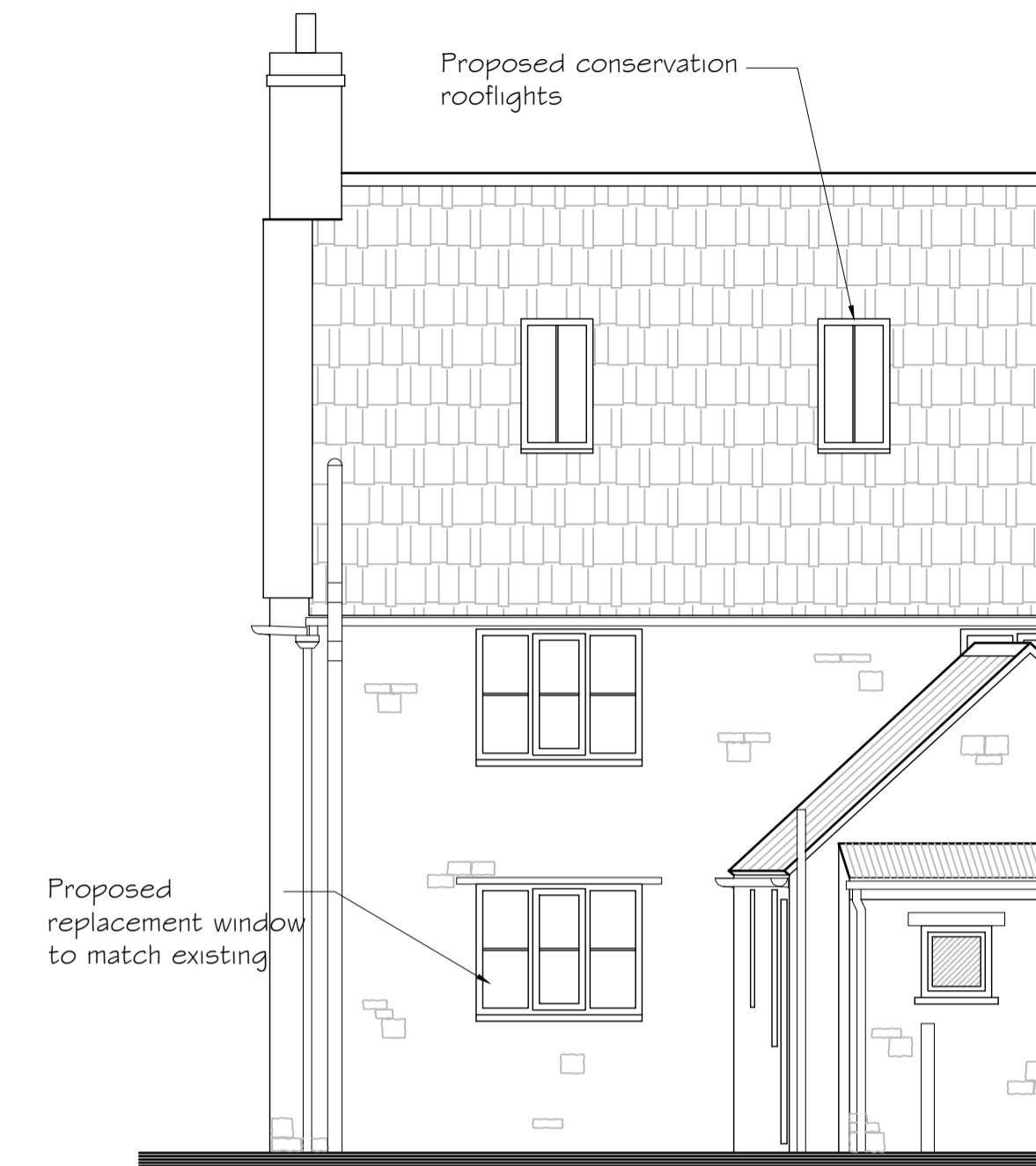

Details of the new window W-01 (not to scale)

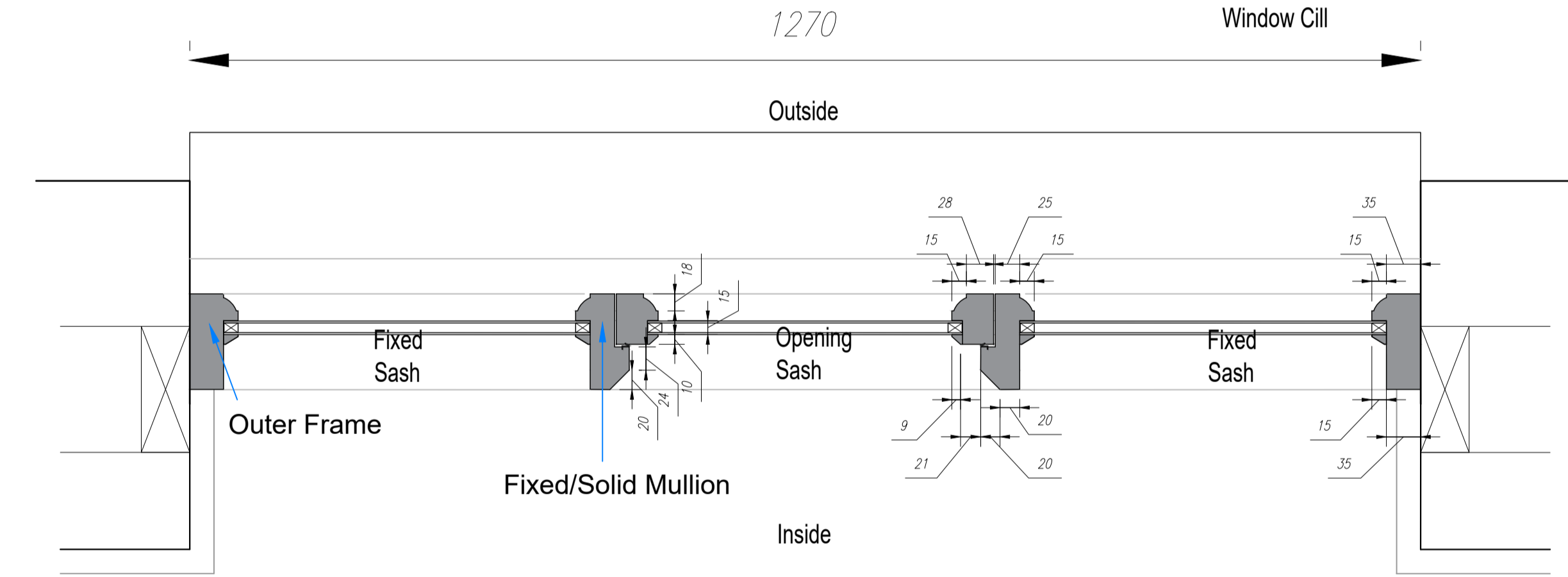

Proposed Window Detail Scale 1:5



Curly Tail (Monkey Tail) Locking Wedge Fastener 57mm - Right Hand by Old Hill Ironworks

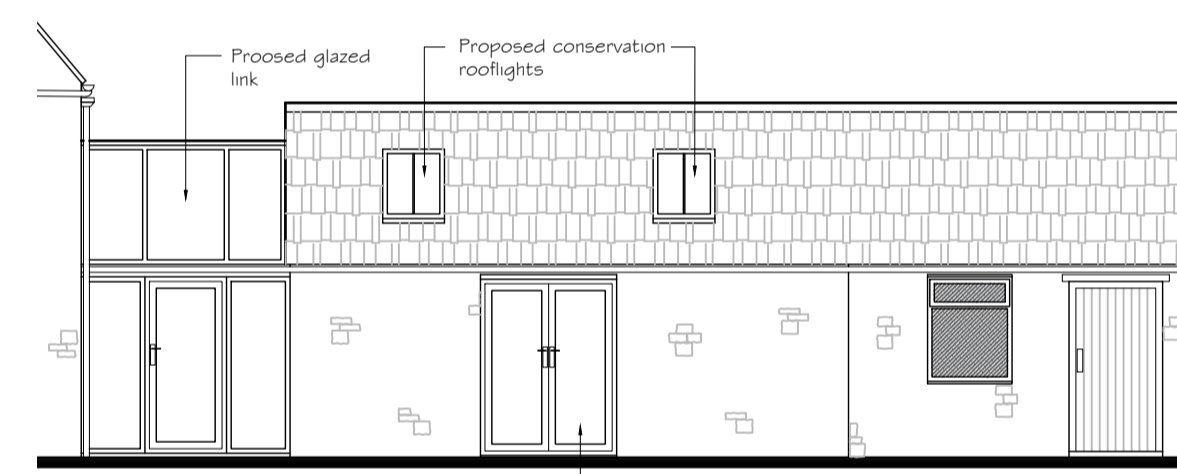

Details of the new doors D-01 (not to scale)



Curly Tail (Monkey Tail) Casement Stay 305mm - Right Hand by Old Hill Ironworks

For rooflight details refer to drawing 21-170-05

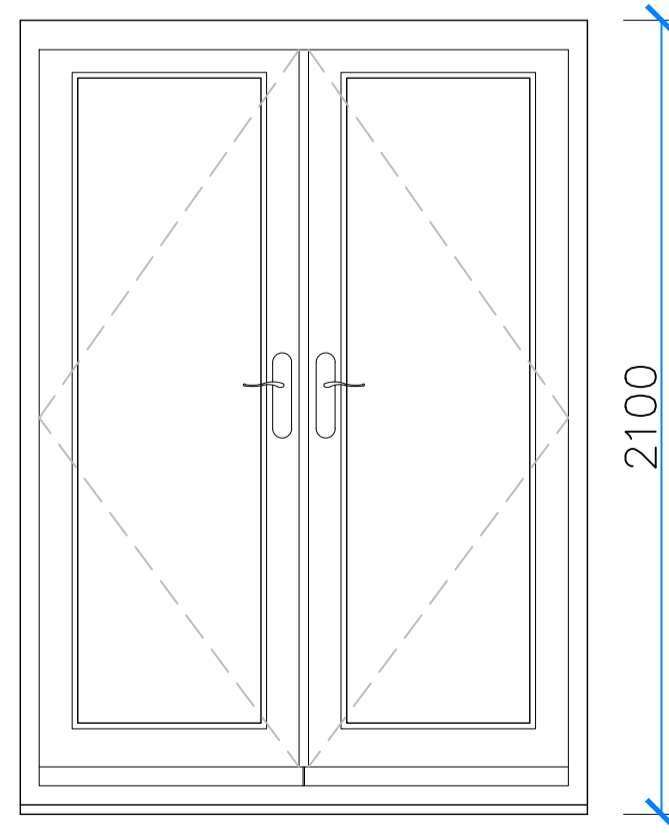

Proposed Door Elevation Scale 1:20

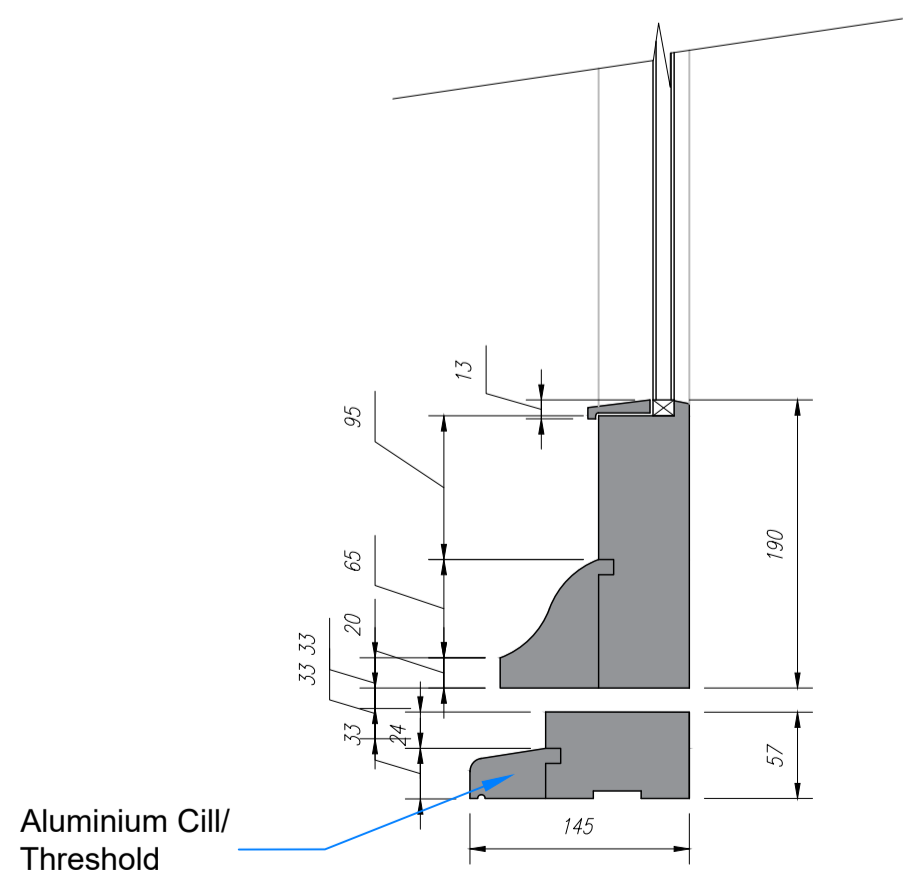

Proposed Door Section (Bottom) Scale 1:5

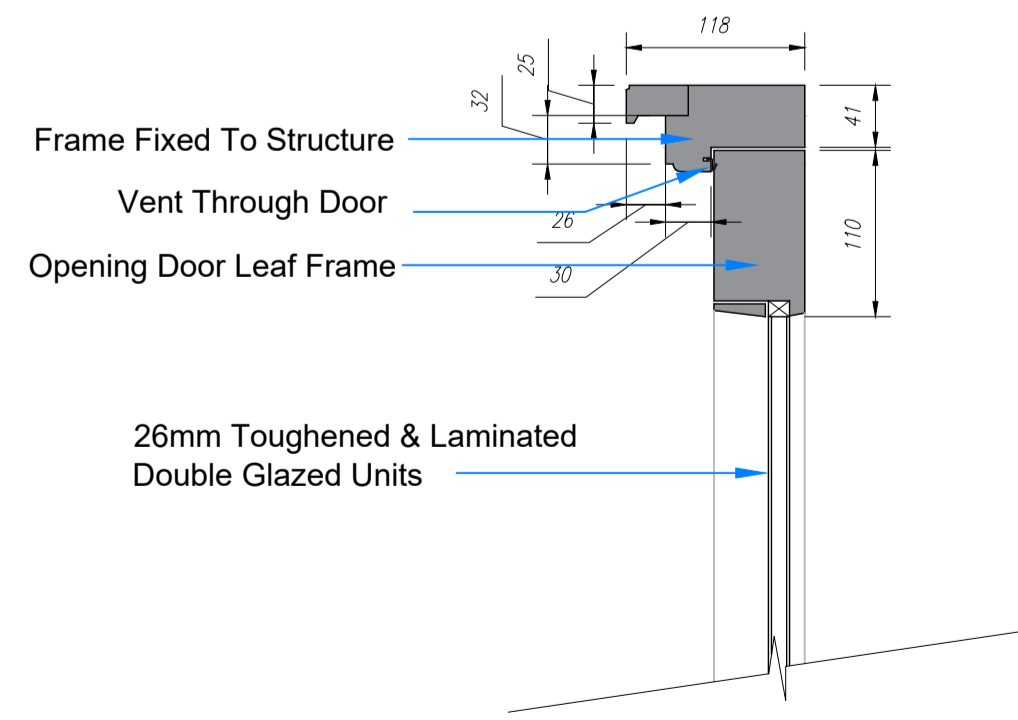

Proposed Door Section (Top) Scale 1:5

Sidey Design
ARCHITECTURE
10 MARKET SQUARE, HIGHAM FERRERS, NN10 8BT
TEL: 01933 317967 FAX: 01933 311161
EMAIL: enquiries@sideydesign.co.uk WEBSITE: www.sideydesign.co.uk

Client: Mr A.Hughes
Title: Proposed Alterations to a Listed Building at 45 Main Street, Aldwincle, Kettering NN14 3EL
Drawing: Proposed Door & Window Details

Date	Drawn	Checked	Scale	Drawing No.	Rev.
Mar '24	PW	JMS	As Stated	21-170-04	

Release of Conditions