

NOTES
 Do not scale to ascertain dimensions.
 Figured dimensions and levels should be verified by the Contractor on site before construction.
 Copyright for all designs and drawings in whole or in part shall remain with the company in accordance with The Copyright Act.

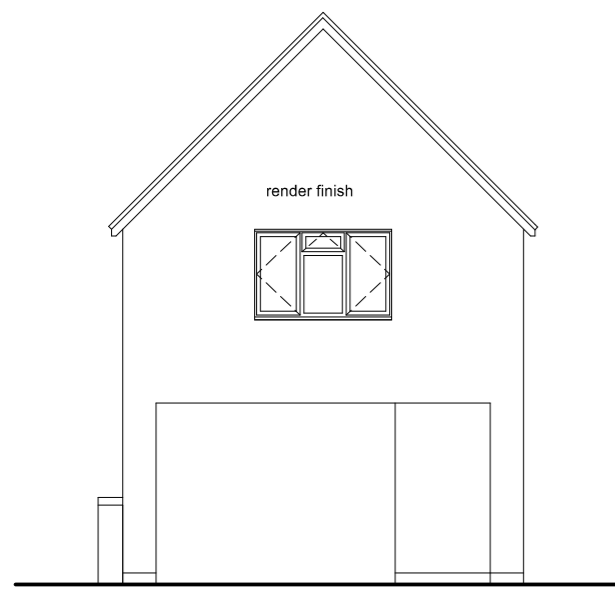

FRONT ELEVATION (EXISTING)

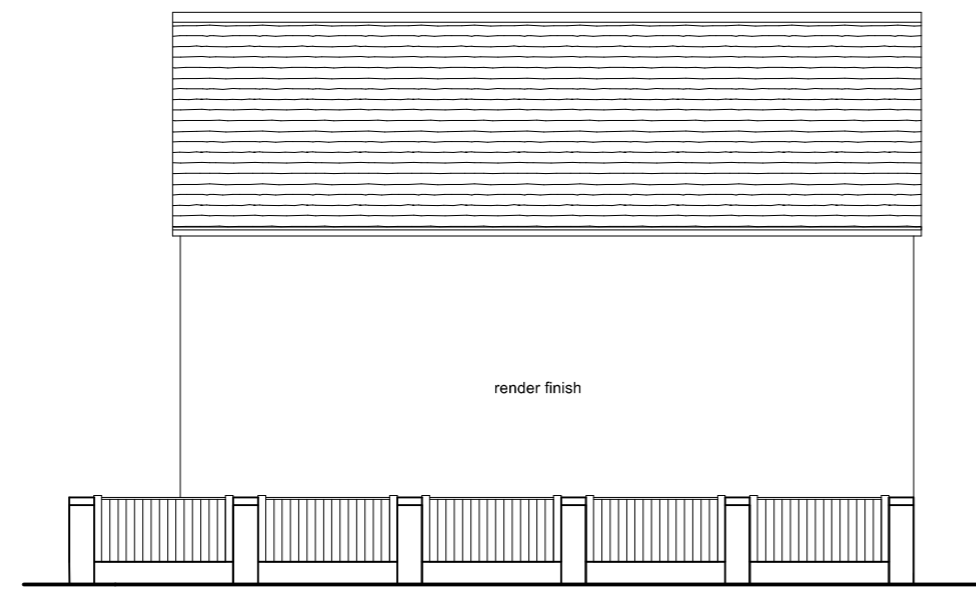

SIDE ELEVATION (EXISTING)

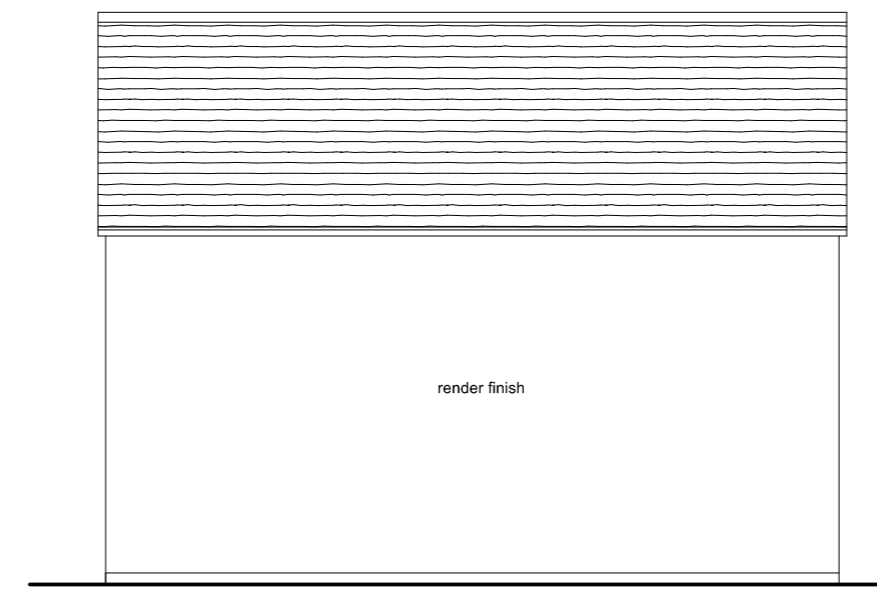

SIDE ELEVATION (EXISTING)

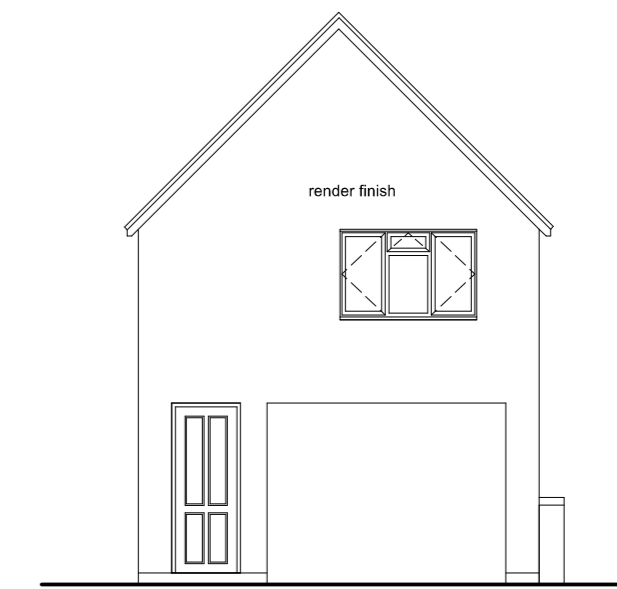

REAR ELEVATION (EXISTING)

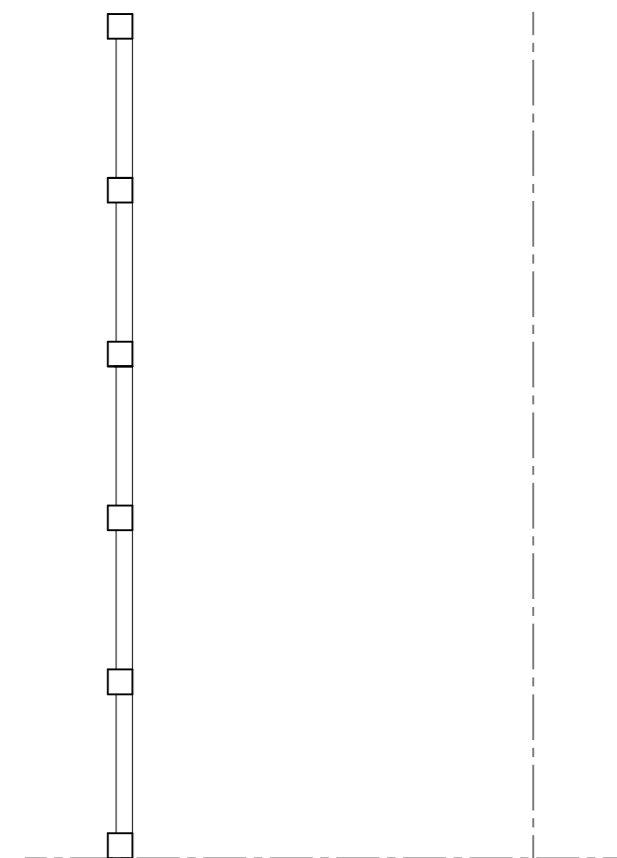

GROUND FLOOR (EXISTING)

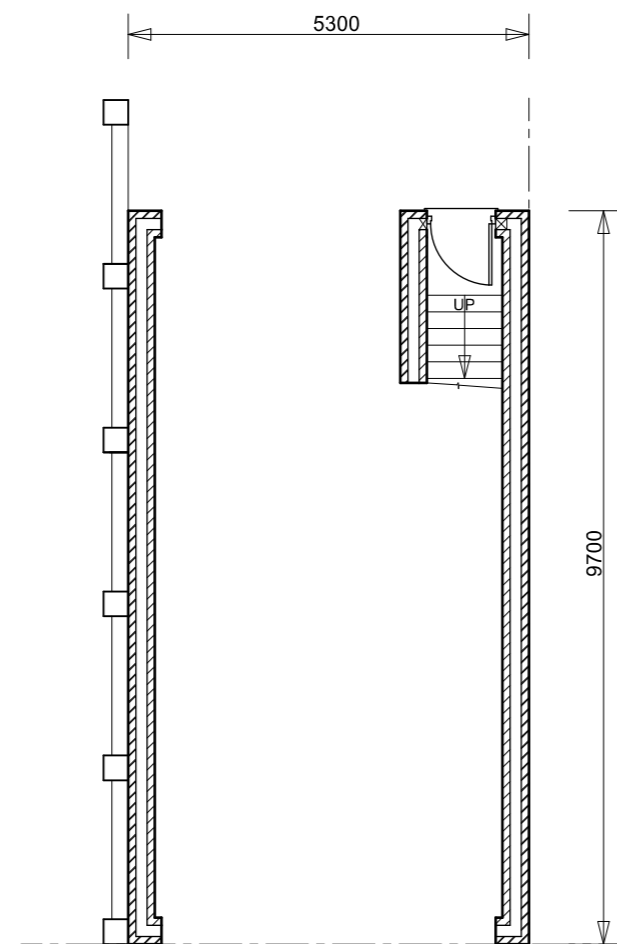

GROUND FLOOR (PROPOSED)

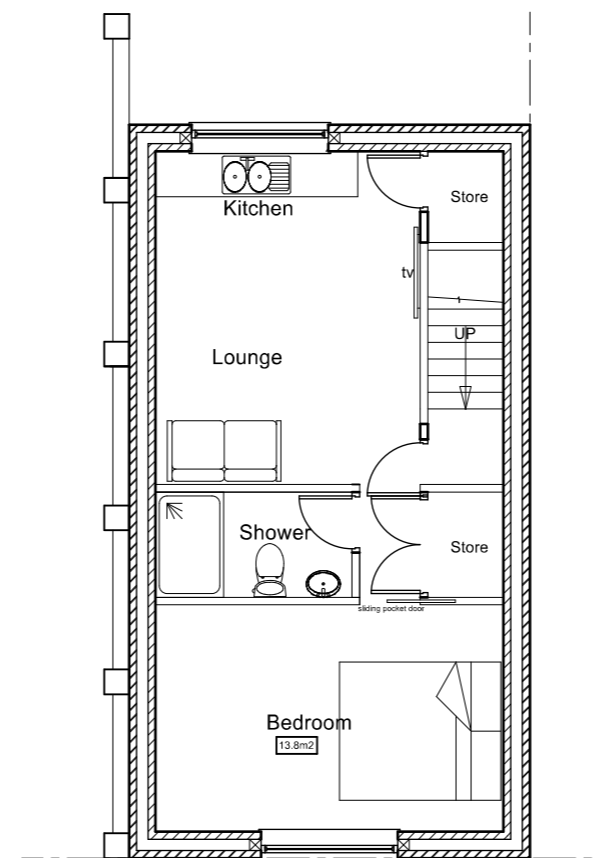

FIRSTFLOOR (PROPOSED)

1:100 SCALE BAR

PRELIMINARY

REV	DATE	DESCRIPTION

©COPYRIGHT

Drawing Office Associates Ltd

CLAYDON HOUSE
 1 EDISON ROAD
 AYLESBURY
 BUCKS
 HP19 8TE
 TEL: 01296 431374

CLIENT
Mr M Champney

PROJECT
**57, Buckingham Road
 Aylesbury**

DETAIL
Plans & Elevations

SCALE	1:100	SCH	DRAWN
DATE	MAR24		APPROVED
JOB NO.	24/2419	DRAWING NO.	1