

PROPOSED GROUND FLOOR PLAN

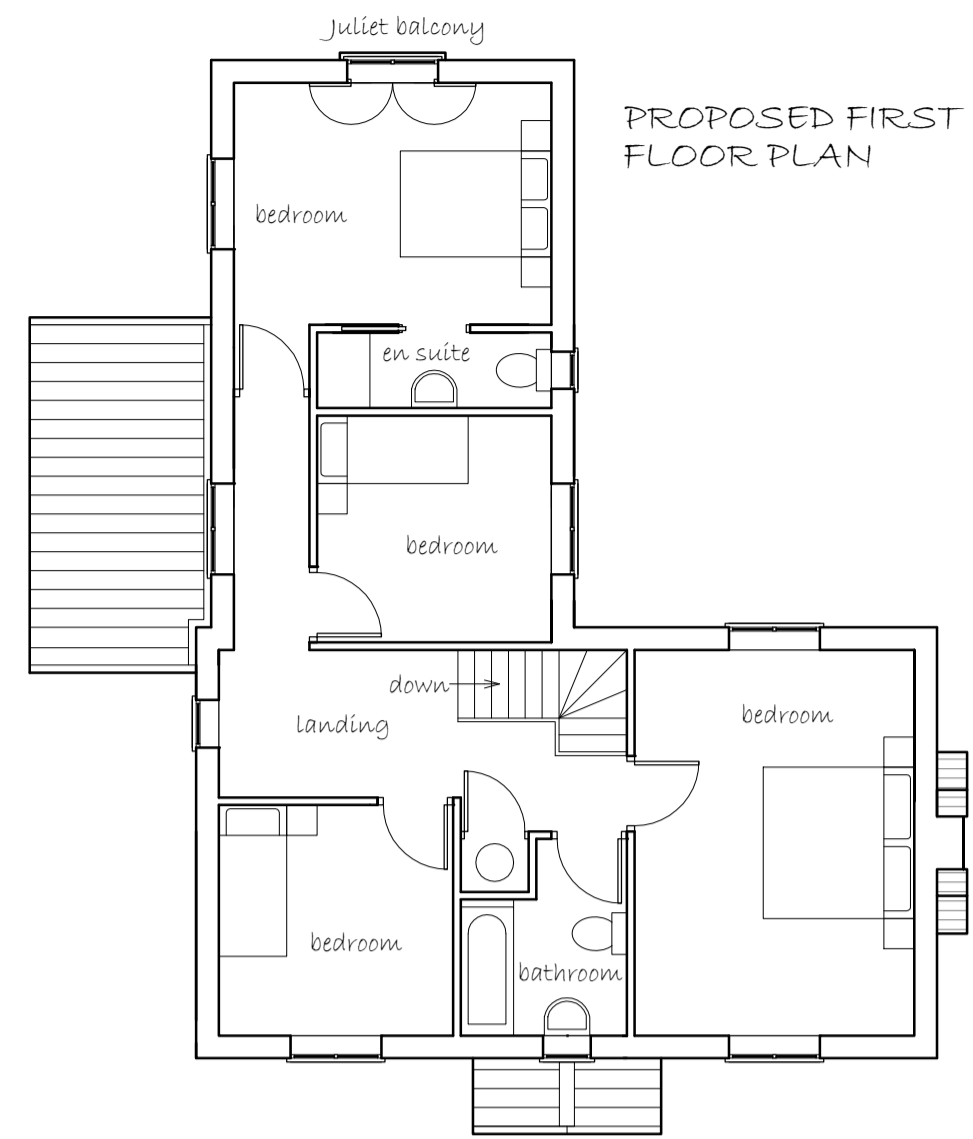

PROPOSED FIRST FLOOR PLAN

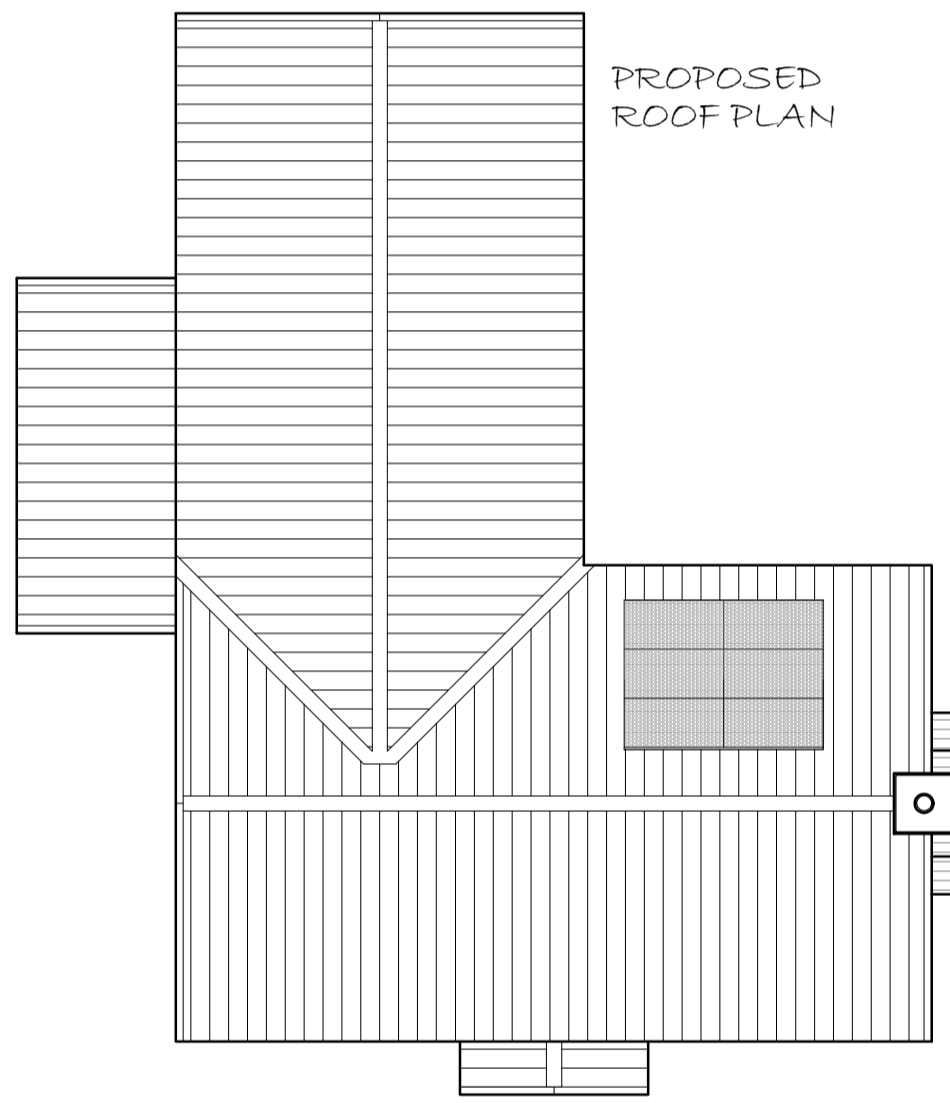

PROPOSED ROOF PLAN



PROPOSED NORTH-WEST FRONT ELEVATION

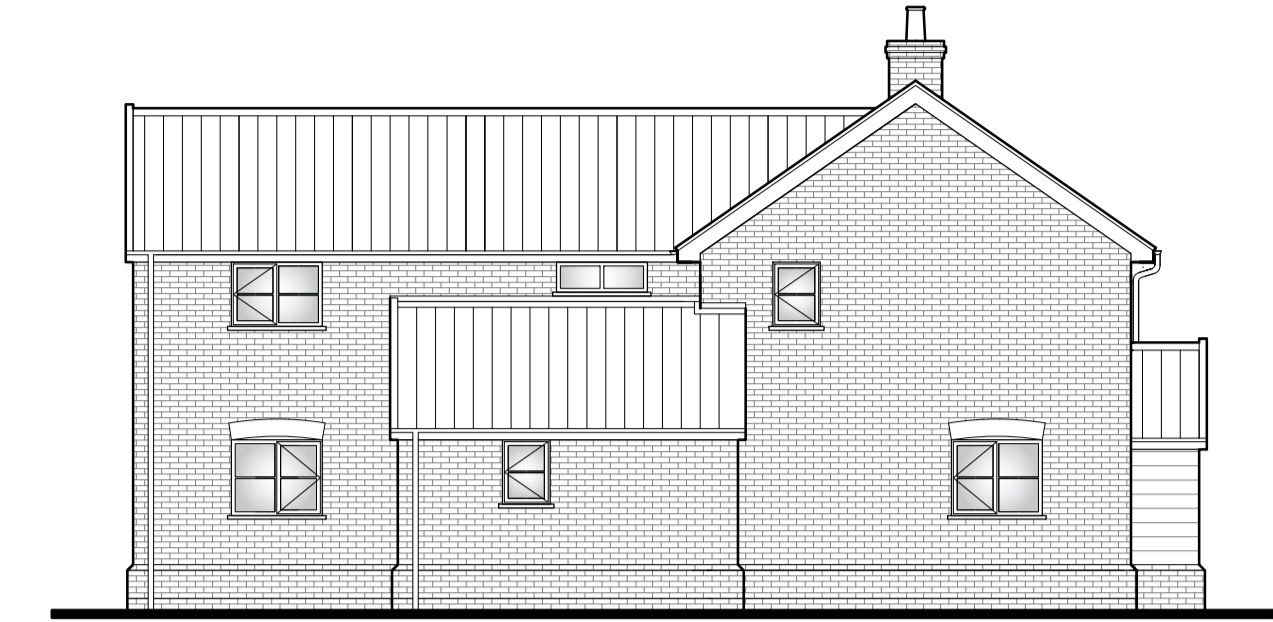

PROPOSED NORTH-EAST SIDE ELEVATION



PROPOSED SOUTH-EAST REAR ELEVATION



PROPOSED SOUTH-WEST SIDE ELEVATION

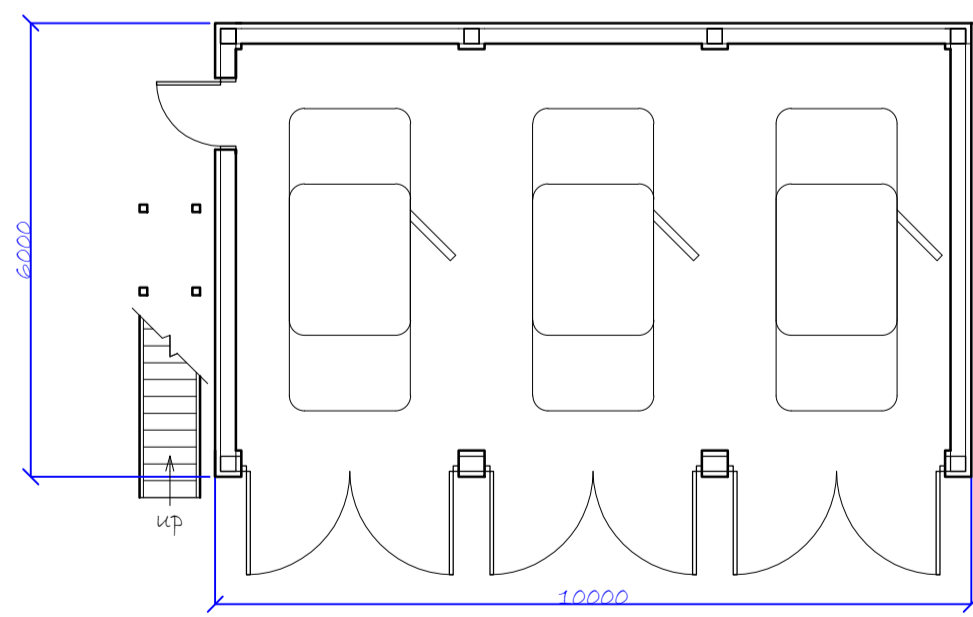

PROPOSED GROUND FLOOR PLAN

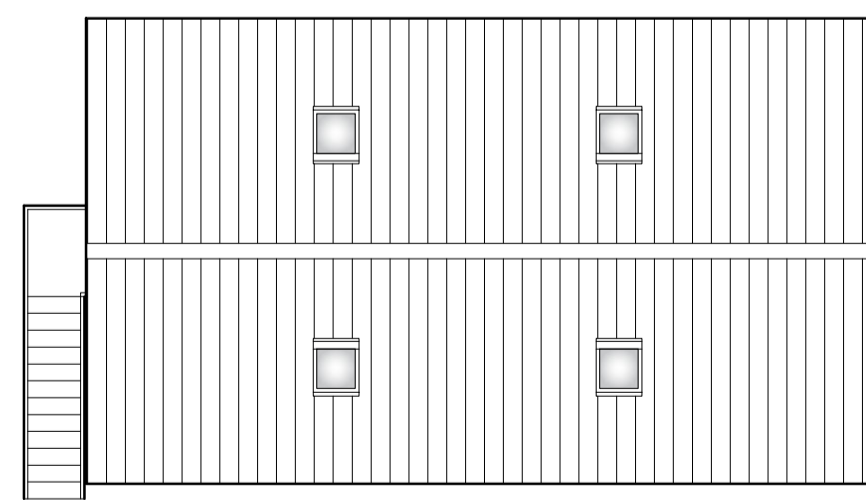

PROPOSED FIRST FLOOR PLAN

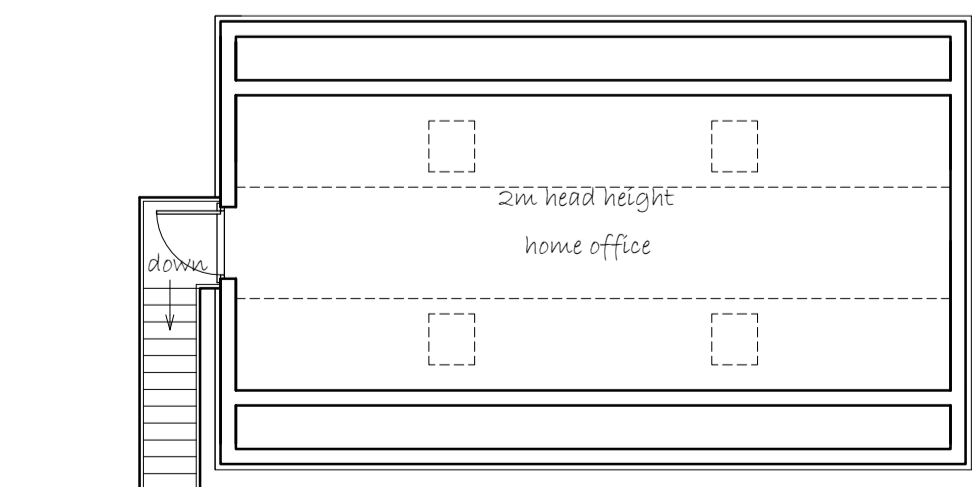

PROPOSED FIRST FLOOR PLAN

GARAGE

4 No Velux 606 x 978

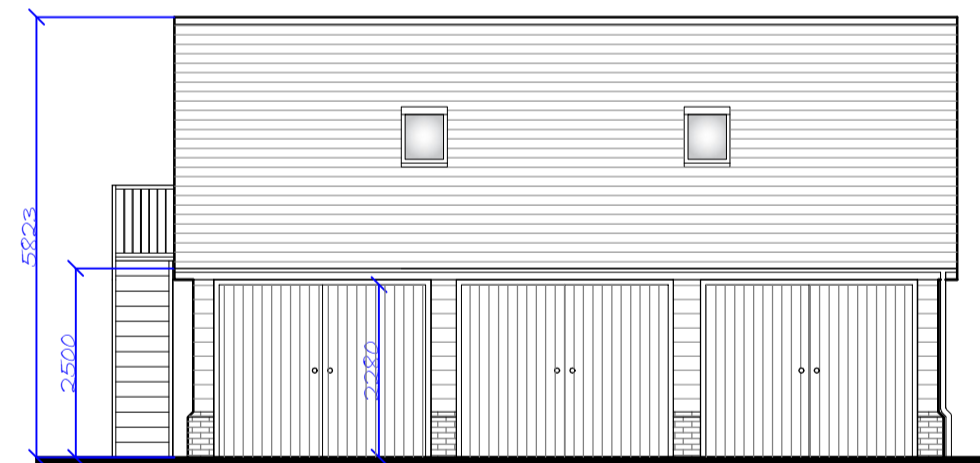

PROPOSED SOUTH FRONT ELEVATION



PROPOSED WEST SIDE ELEVATION

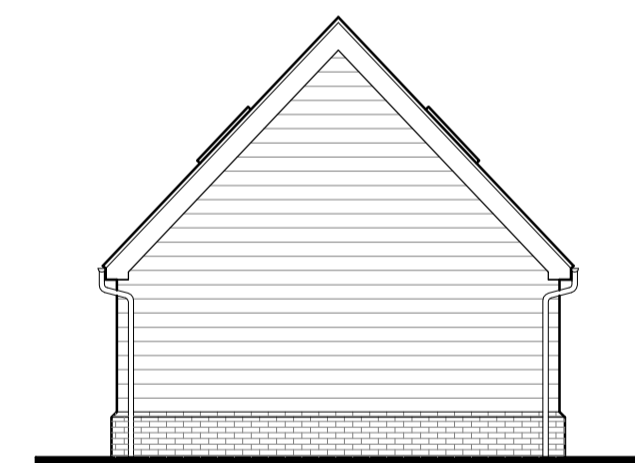

PROPOSED EAST SIDE ELEVATION

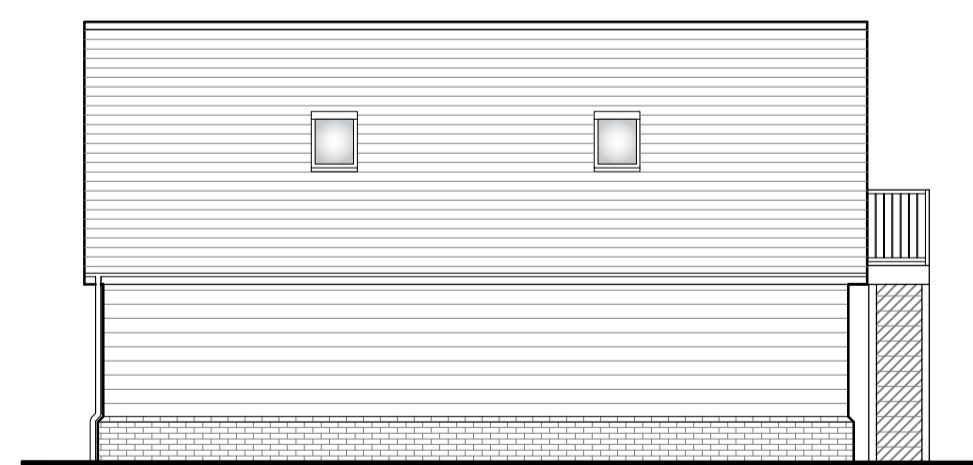

PROPOSED NORTH REAR ELEVATION

GARAGE

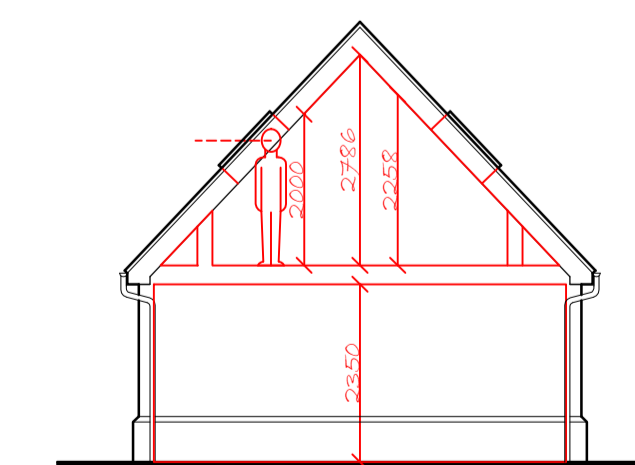

SECTION THROUGH PROPOSED EAST SIDE ELEVATION SHOWING HEAD HEIGHTS

GARAGE

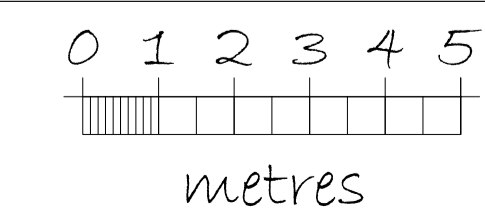

FOR PLANNING PURPOSES FROM A MEASURED SURVEY. PLEASE CHECK ALL MEASUREMENTS ON SITE.

**Alan Stannard Planning Agent**  
29 Consort Avenue, Rackheath, Norwich NR13 6FQ  
Tel: 07788577867 Email: alanstannard@hotmail.com

Clare and Steve Corbett  
Little Boats Hall, Badingham Road, Laxfield IP13 8HU  
SCALE 1:100 AB 1 - 20.03.2024