

Section AA

141

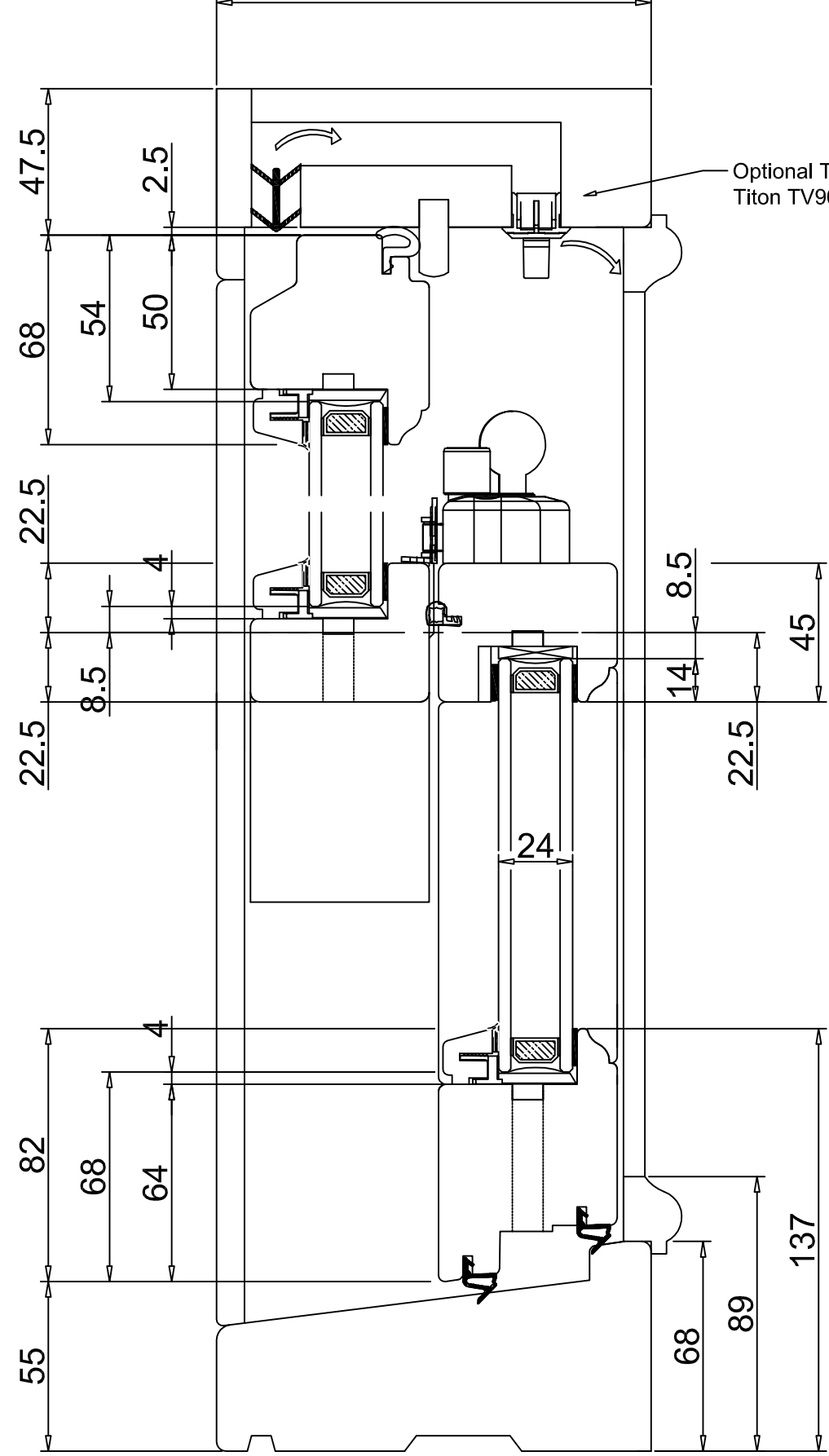

Optional Trickle Vents
Titan TV90

Spring Balance

116

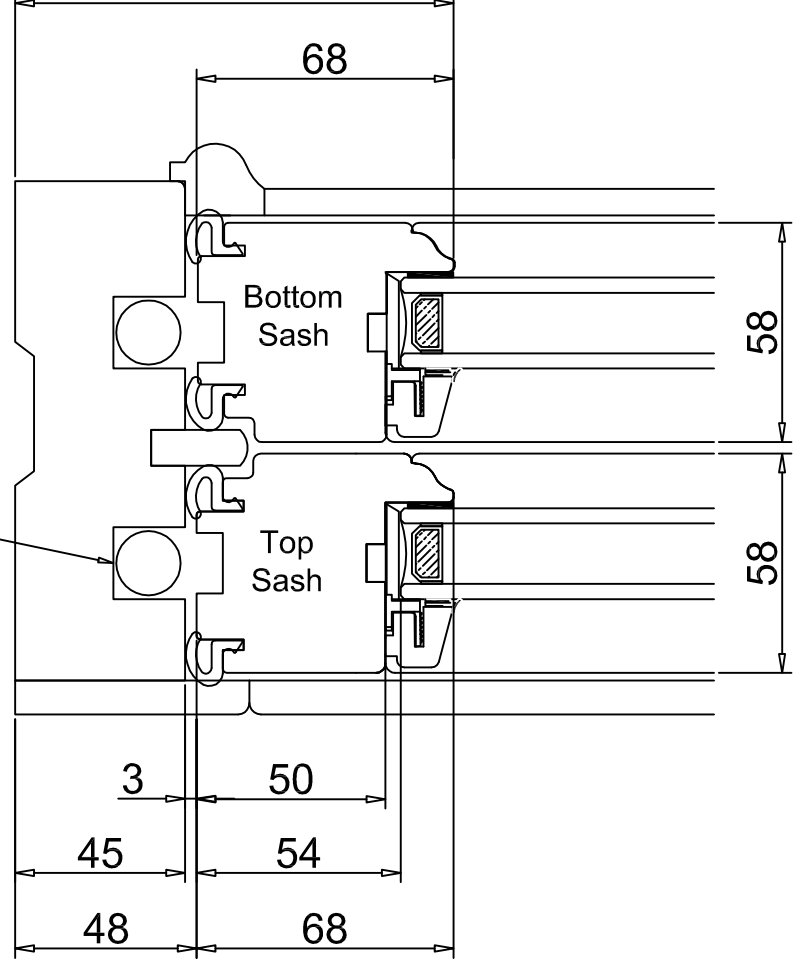

Bottom Sash

Top Sash

66

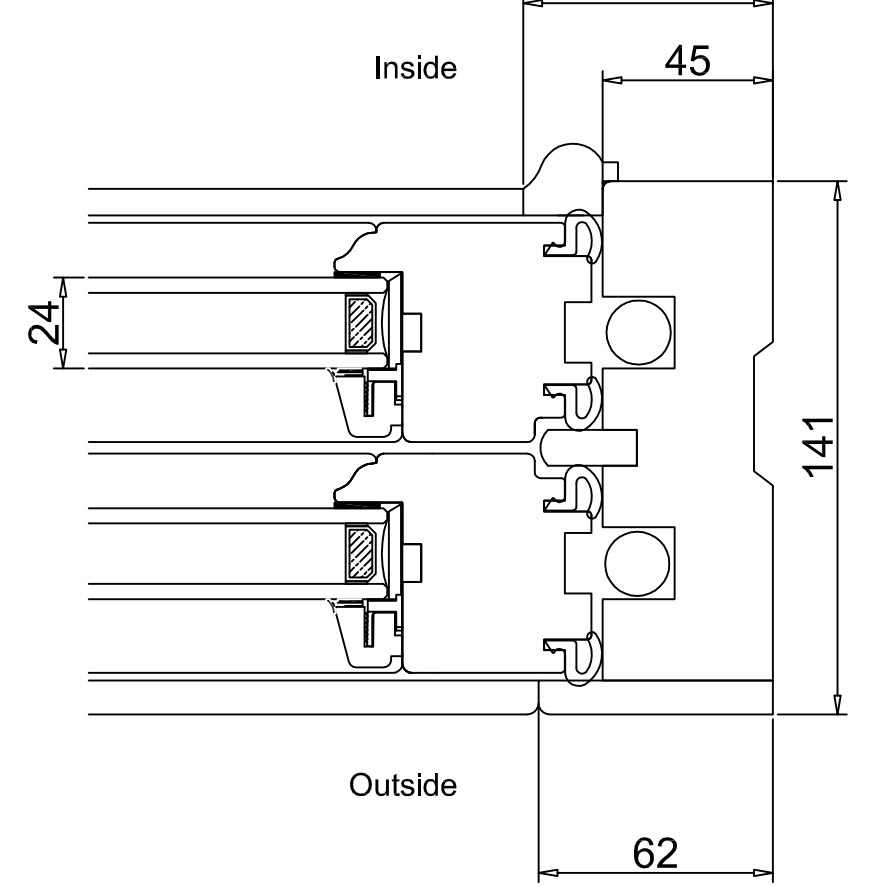

Inside



45

Outside

62

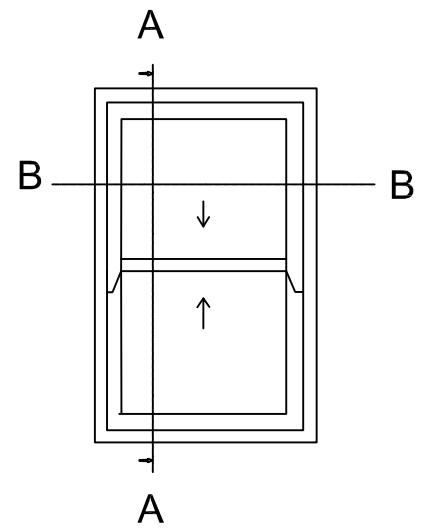
Section BB



Rev	Description	Name	Date			Name	Date	Scale
Rev	Description	Name	Date			P.A.Lake	01.12.16	1:2
Rev	Description	Name	Date			Design Approval <i>MJC</i>	Technical Approval <i>DJO</i>	Sheet A3
Rev	Description	Name	Date	TIMBER GENERAL ARRANGEMENT SPIRAL SASH WINDOWS				
Rev	Description	Name	Date	Product Codes HS		Drawing No. GA770		Revision