

detail 01

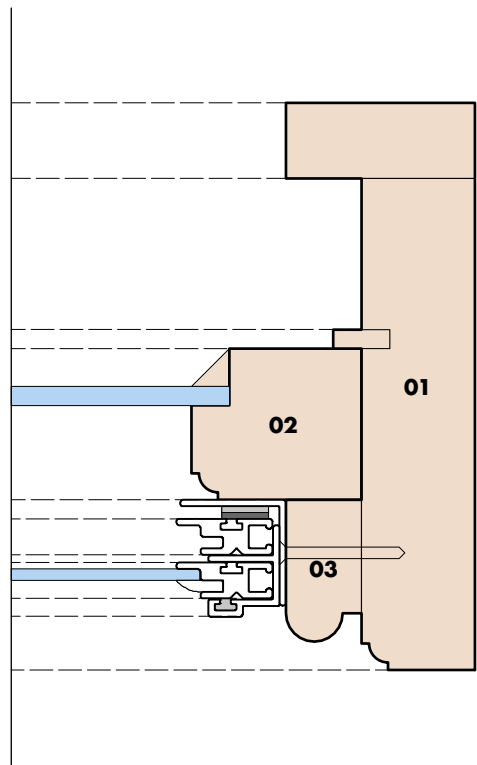

detail 02

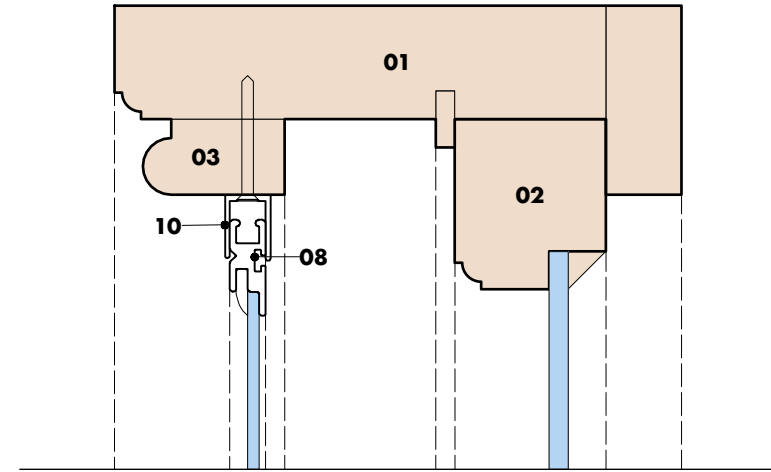

detail 03

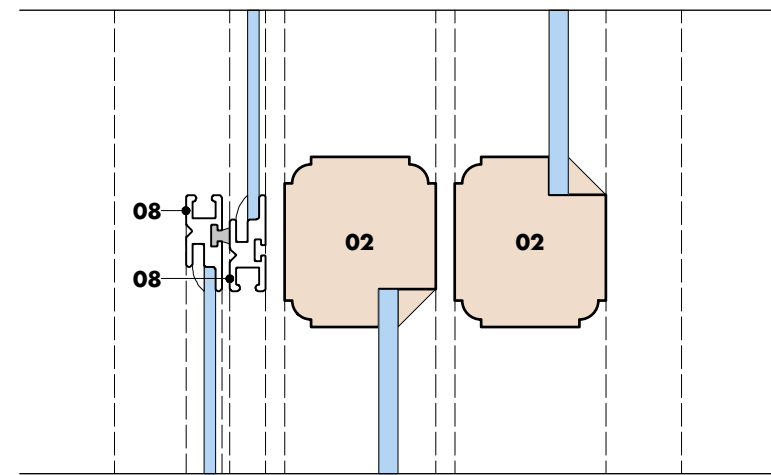

detail 04

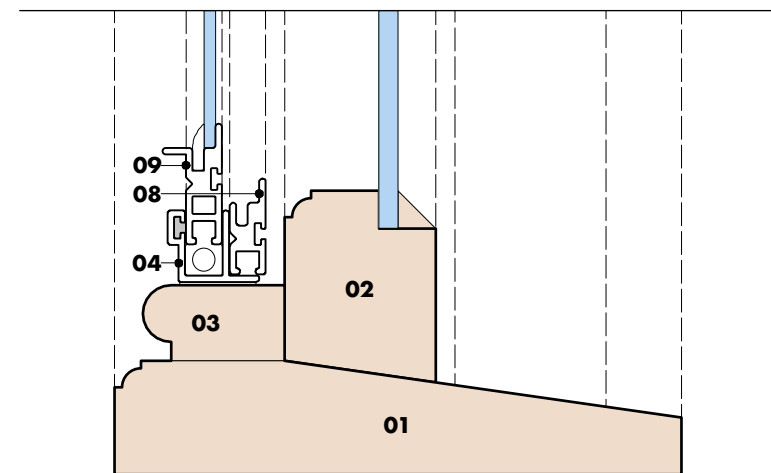

detail 05

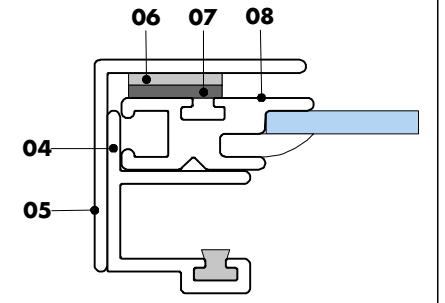

detail A - scale 1:1

key

- 01 existing frame
- 02 existing window
- 03 existing staff bead
- 04 C-S3
- 05 aluminium L section
- 06 steel strip
- 07 rubberised magnetic strip
- 08 D-42
- 09 D-46
- 10 deep guide

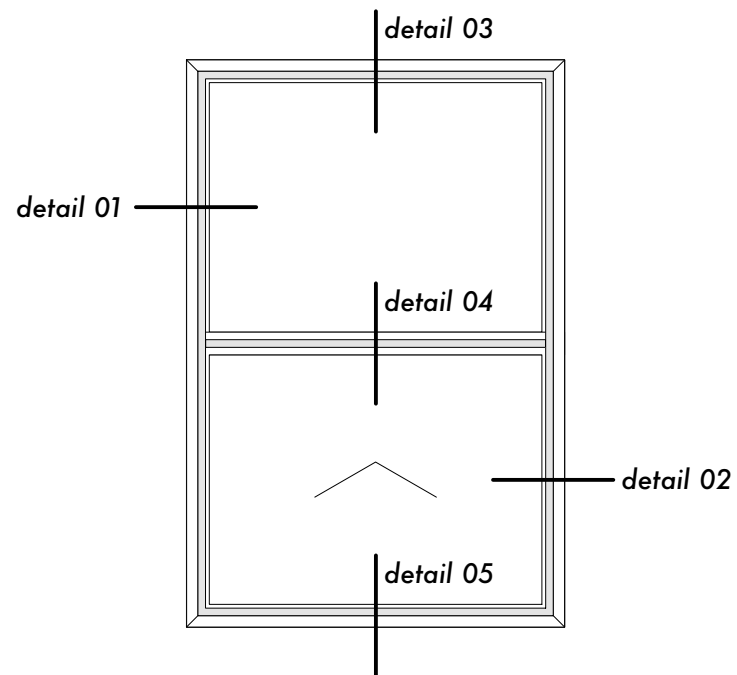
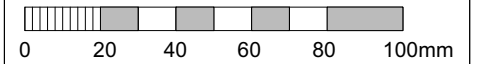

detail key

Title: **LVSS SB**  
 Number: **SW.004**  
 Notes: typical cross sections through LVSS unit in staff beads  
 Revision: -  
 Date: 20.07.17  
 Status: Construction  
 Drawn: A.B  
 Scale: 1:2 @ A3



**STORM**

BESPOKE SECONDARY GLAZING