

manuals can be found inside the door of the irrigation unit or can be downloaded from: www.mobilane.com

Code: MT-GN81-230		Drawing nr. nvt		A3	
Remarks: LivePanel irrigation unit					
Version: April 2021					
<small>Deze tekening is eigendom van Mobilane BV, het is niet toegestaan deze te reproduceren of zonder toestemming te gebruiken</small>					

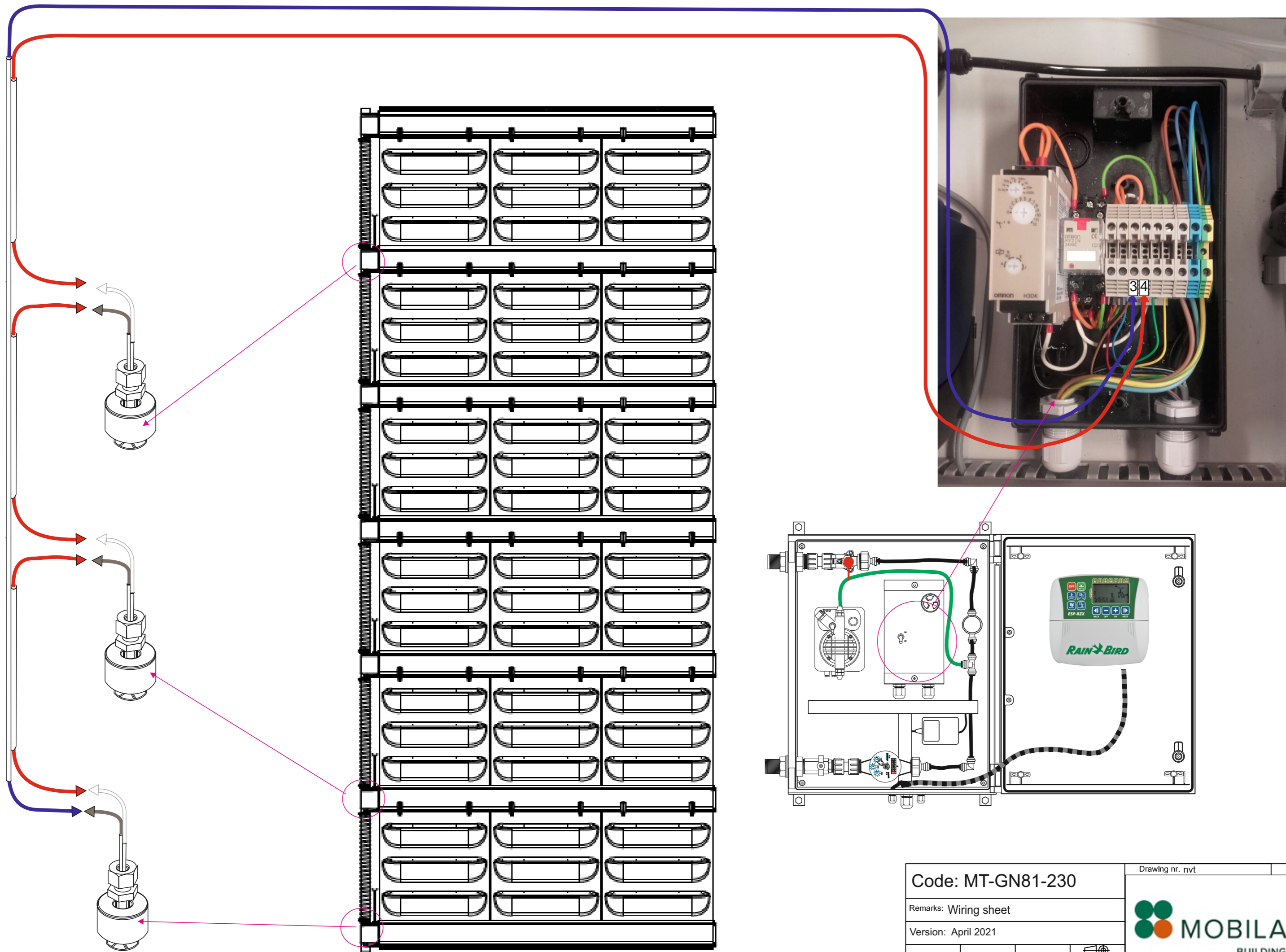

Code: MT-GN81-230

Remarks: Wiring sheet

Version: April 2021

Drawing nr. nvt A3



Deze tekening is eigendom van Mobilane BV, het is niet toegestaan deze te reproduceren of zonder toestemming te gebruiken

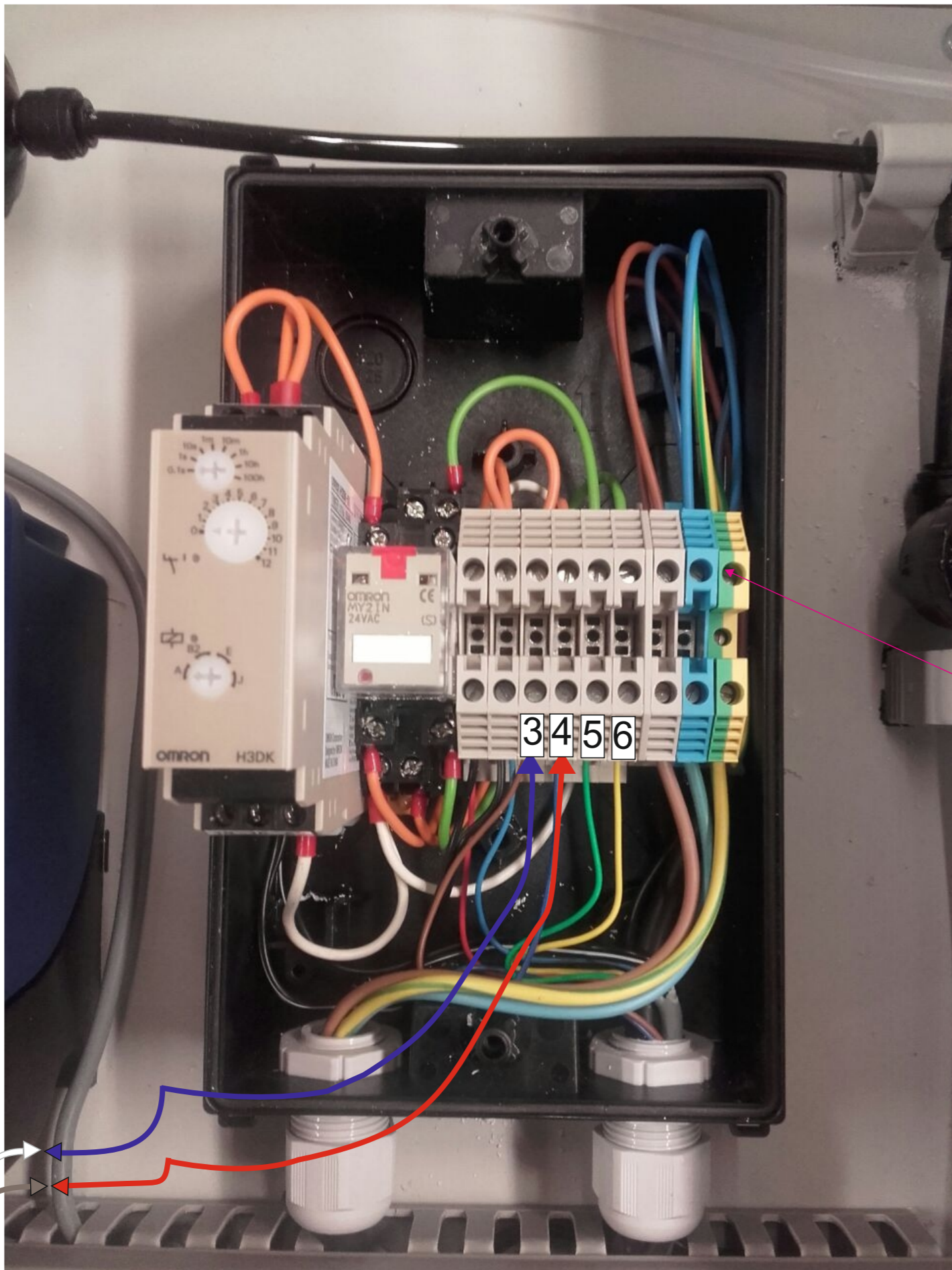

10 hours

x 2.5

manuals can be found inside the door of the irrigation unit or can be downloaded from: www.mobilane.com

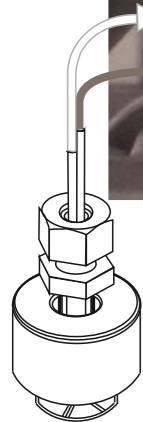
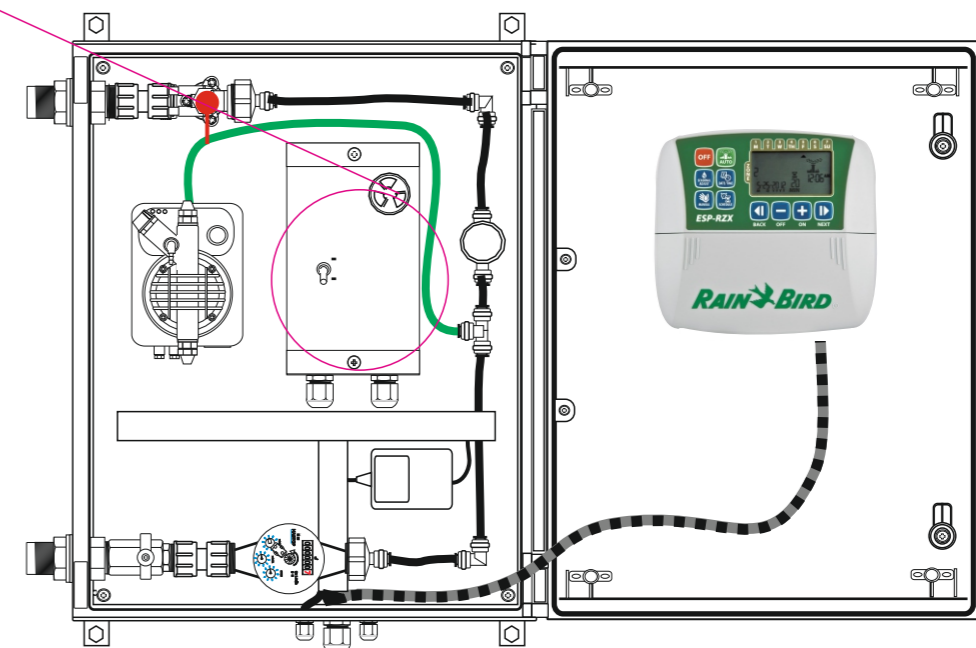

Code: MT-GN81-230

Remarks: Wiring sheet

Version: April 2021

Drawing nr. nvt

A3



Deze tekening is eigendom van Mobilane BV, het is niet toegestaan deze te reproduceren of zonder toestemming te gebruiken

Note:

The SMS alarm dialer has its own SIM card.
Important: there must be sufficient signal strength available

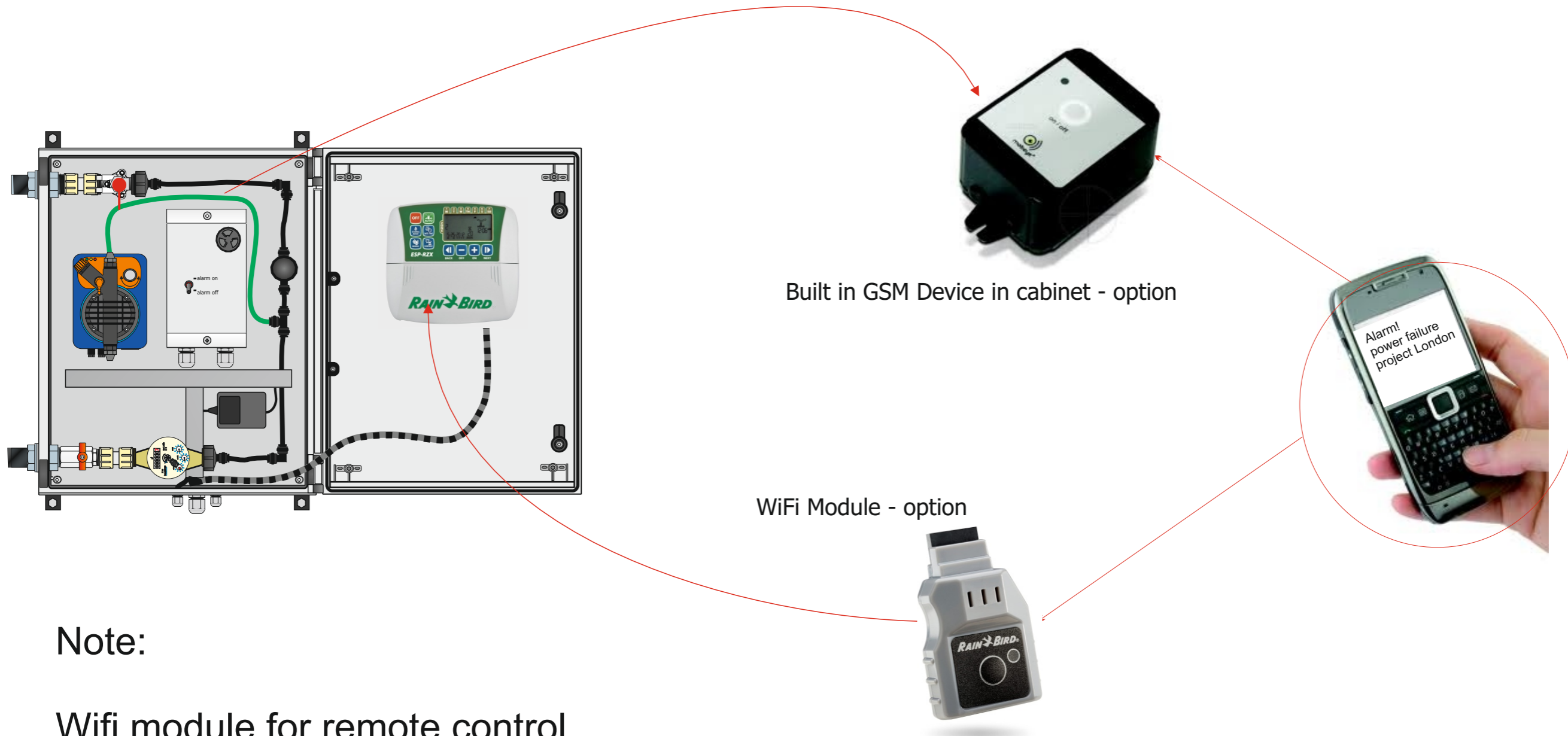

Note:

Wifi module for remote control
of the irrigation controller via mobile phone.
A working wifi network must be present

Code: MT-GN81-INTERN SMS (Parts)	Drawing nr. nvt	A3
Code: MT-GN81-WIFI LINK		
option: WiFi Module/GSM Device		
Version: April 2021		
Deze tekening is eigendom van Mobilane BV, het is niet toegestaan deze te reproduceren of zonder toestemming te gebruiken		



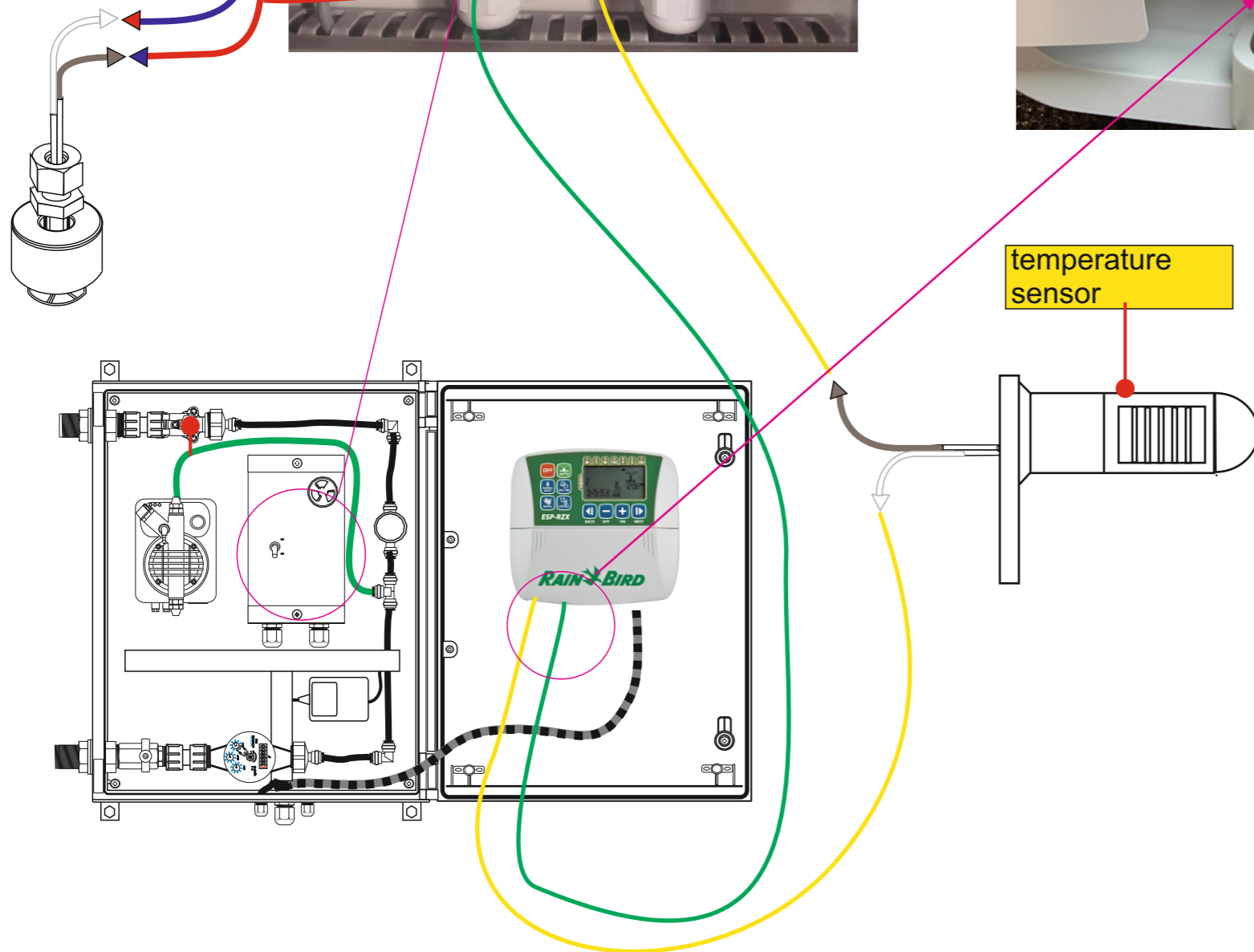
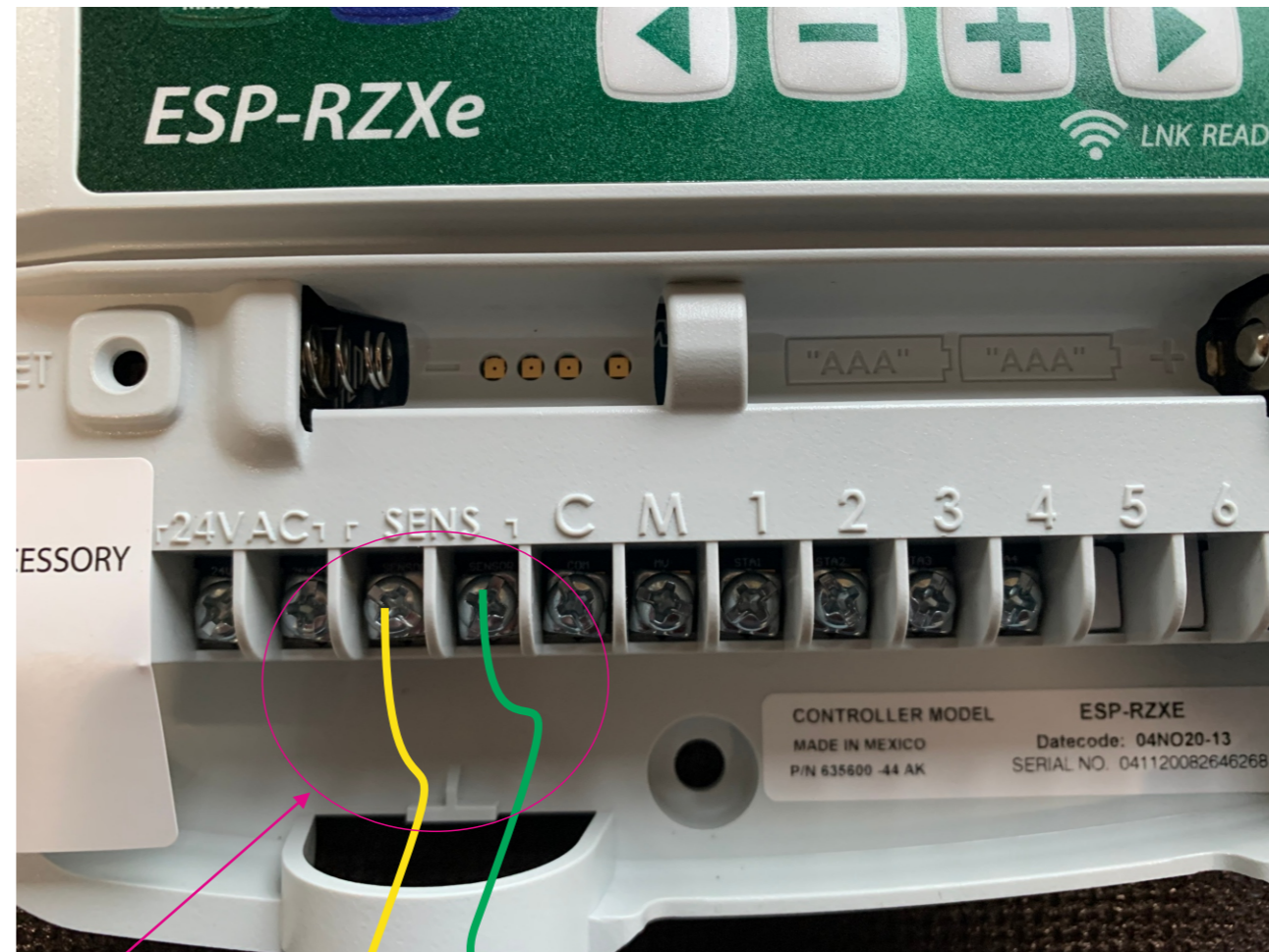
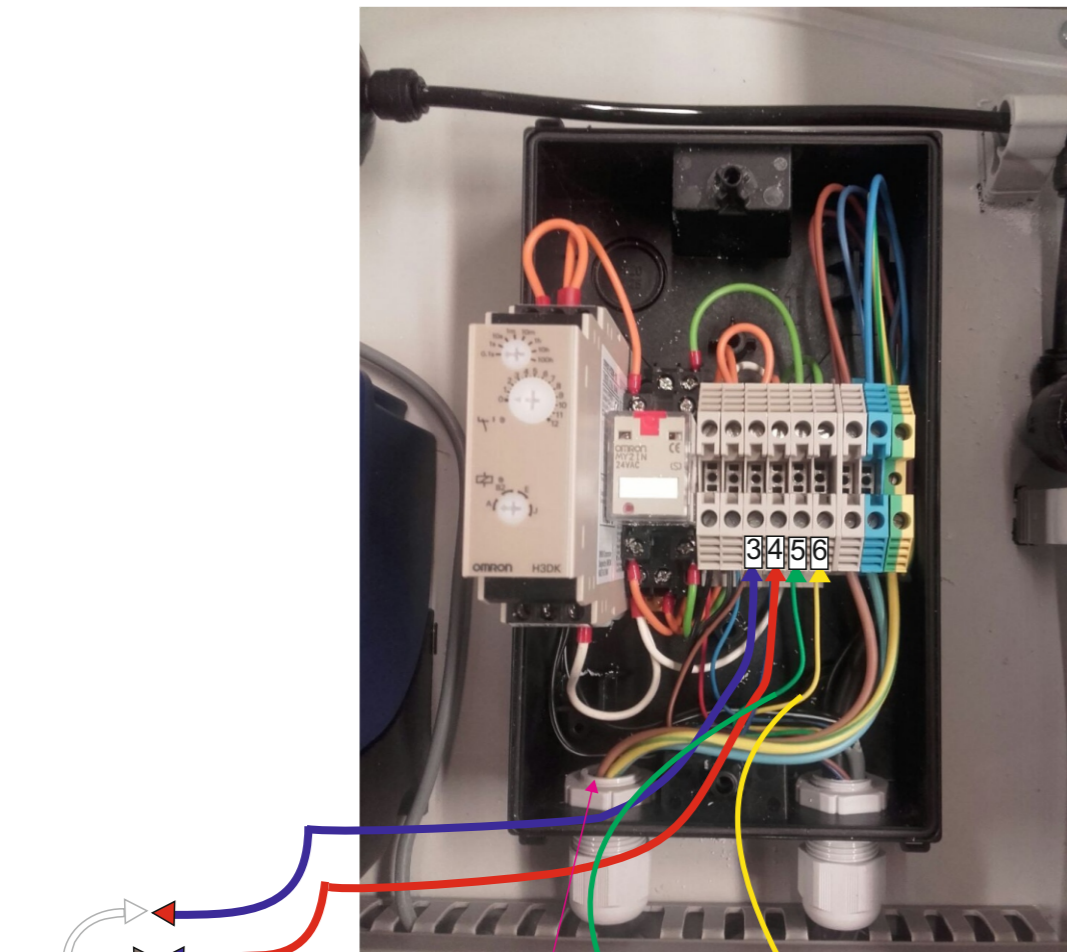

Code: MT-GN81-FREEZE CLICK

option: Temperature sensor (wiring sheet)

Version: April 2021

Drawing nr. nvt

A3



Deze tekening is eigendom van Mobilane BV, het is niet toegestaan deze te reproduceren of zonder toestemming te gebruiken

To bleed the pulse pump:

Fill up the tank and open button **B** by turning it to the left.

Put the switch underneath the injectionpump on to **T** and turn button **C** to the right completely.

Start the irrigation program by opening a valve manually.

The irrigationprogram and the injectionpump will start to work.

Wait till fertilizer is coming out of outlet **D** and close button **B** by turning it to the right. Put the swith of the fertilizer back to **F** again.

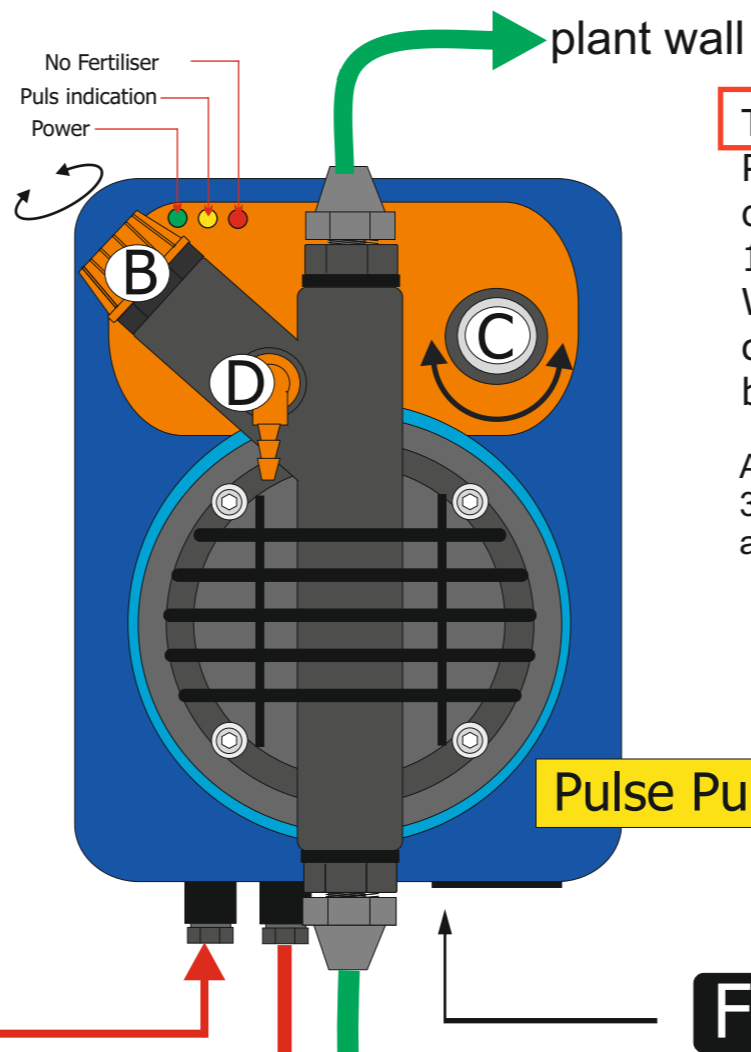

To change the setting of the injectionpump:

Put the switch underneath the injectionpump onto **F** and the pump will give 1 pulse/litre (0.69ml/ltr/5bar- 0.83/ltr/3bar). When you put the switch onto **T** you can change the amount of pulses by turning button **C** to the left or right.

As a general setting the following can be used
3 to 4 pulses per liter during the growing season
and 1 to 2 during autumn.

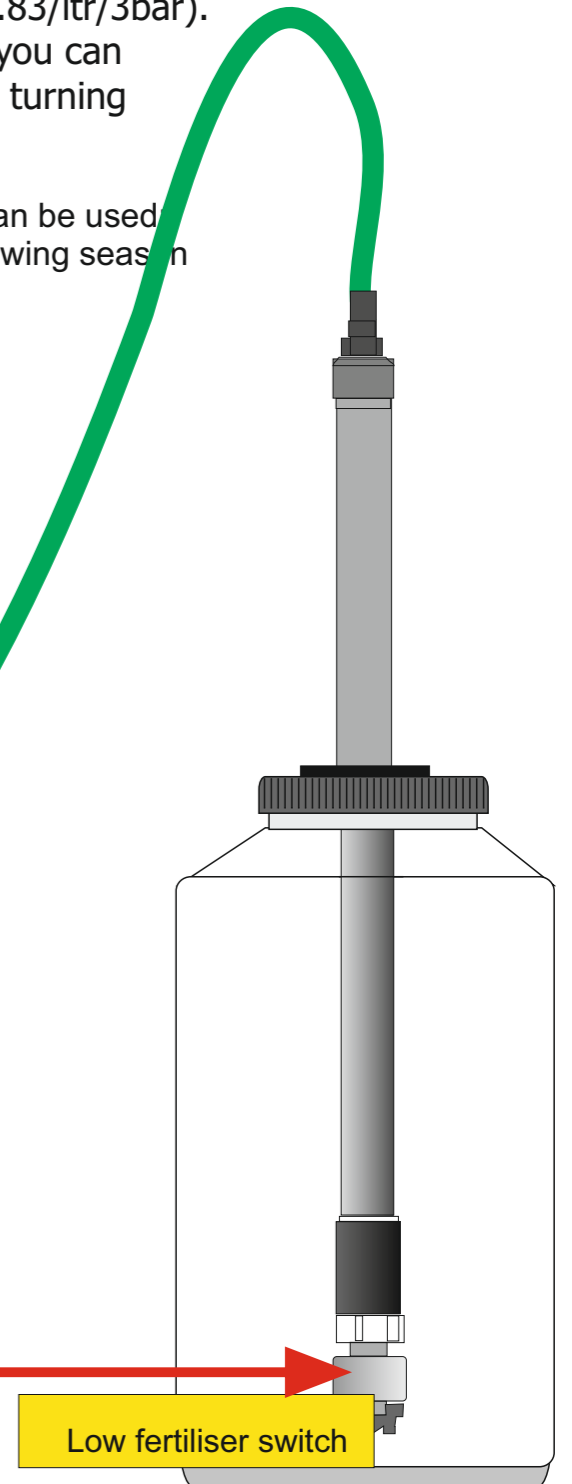
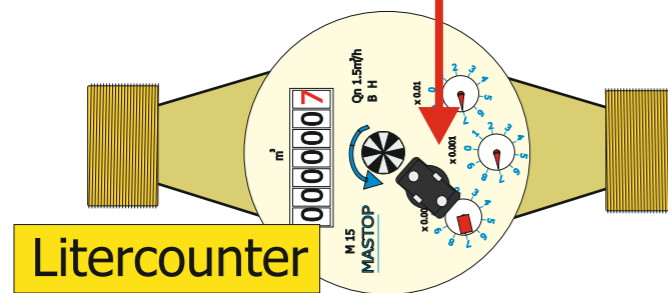

Dosage fertilizer/Ciro CleanDrip: Jerrycan 2.0 ltr:
Dosage 1 pulse per liter (= approx 0.1gr/ltr) 280gr Peters 15+11+29 290ml Ciro Cleandrip
Dosage 2 pulses each liter (= approx 0.2gr/ltr) 280gr Peters 15+11+29 145ml Ciro Cleandrip
Dosage 4 pulses each liter(= approx 0,4gr/ltr) 280gr Peters 15+11+29 75ml Ciro Cleandrip