

01 S02.W1
1:25@A1, 1:50@A3

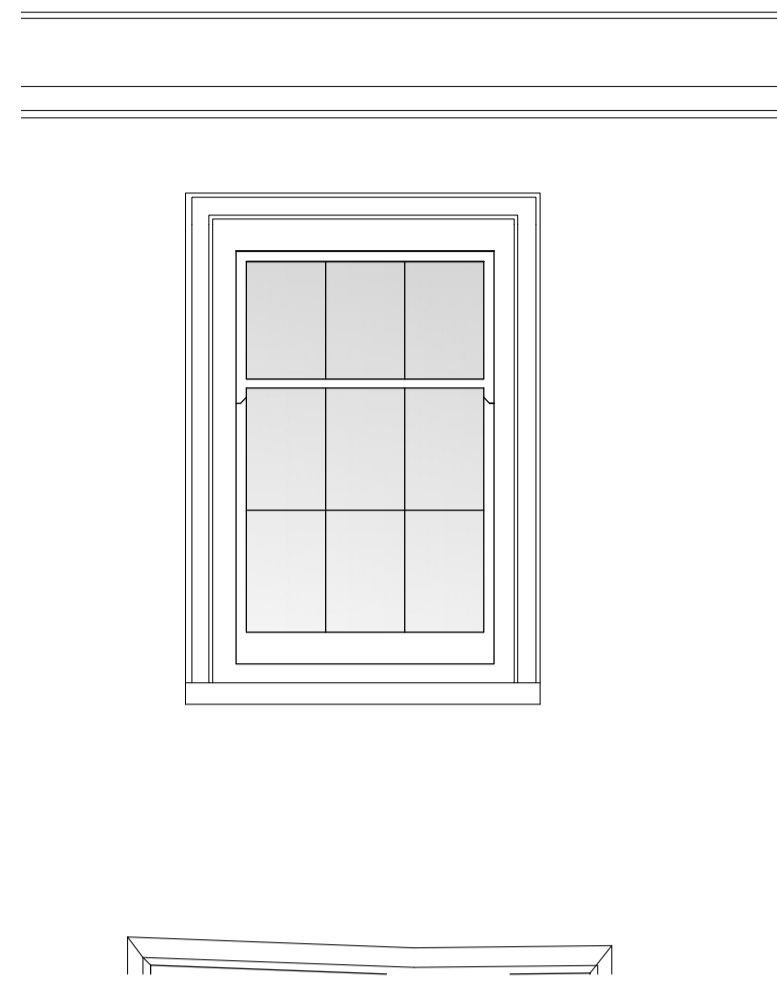

02 S03.W1
1:25@A1, 1:50@A3

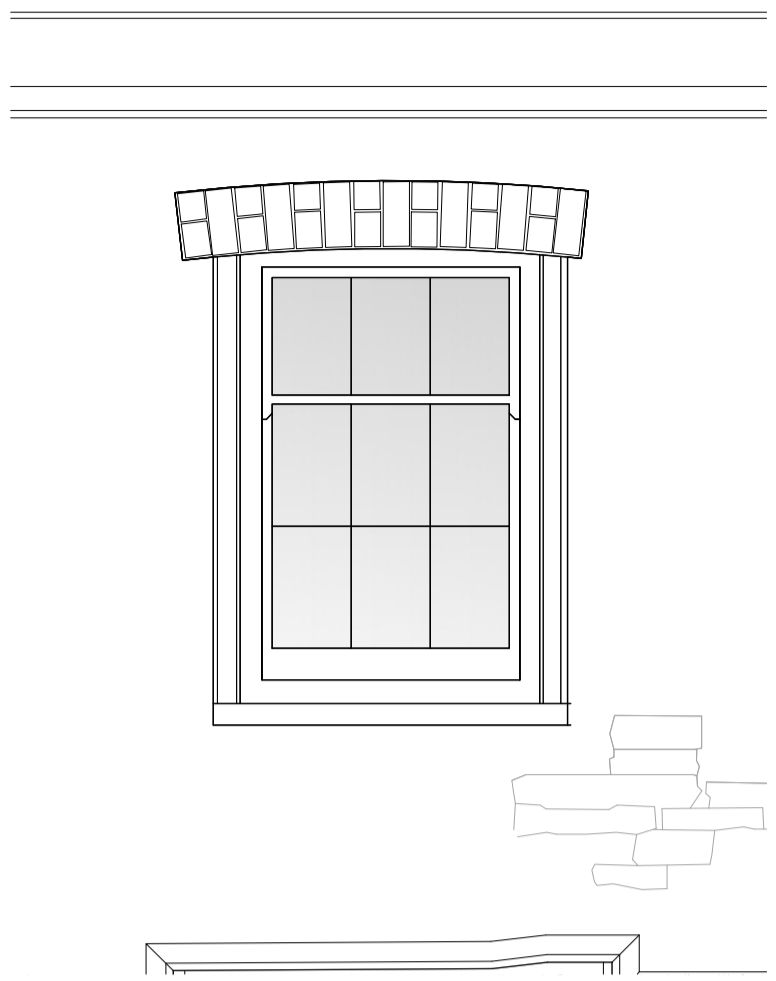

03 S03.W2
1:25@A1, 1:50@A3

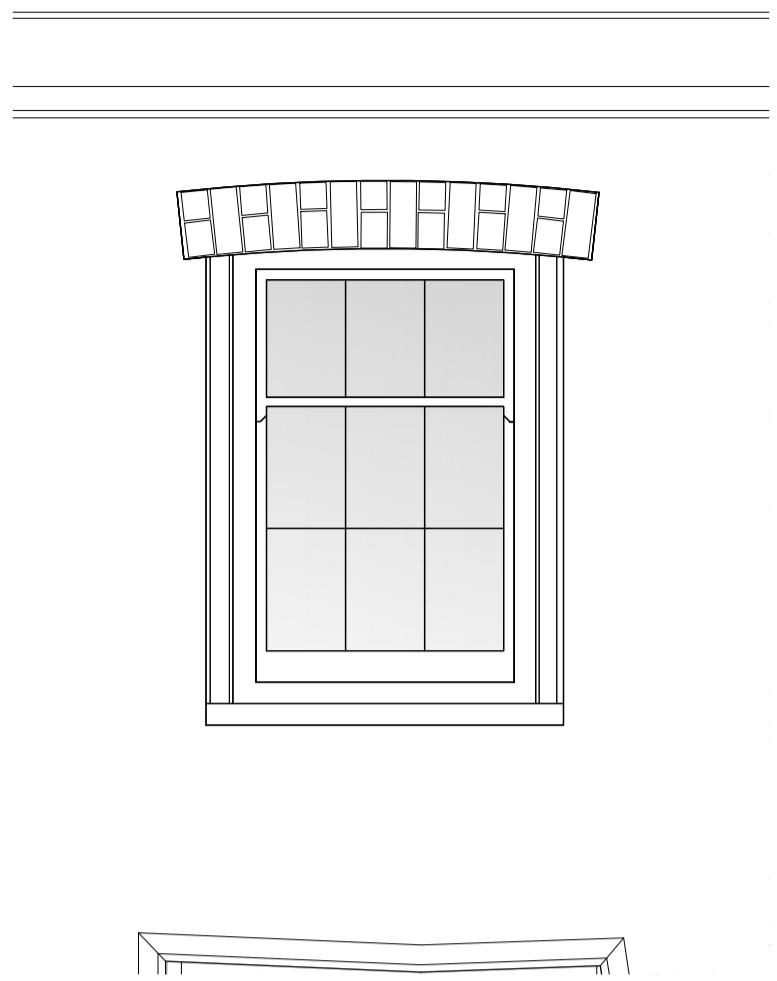

04 S04.W1
1:25@A1, 1:50@A3

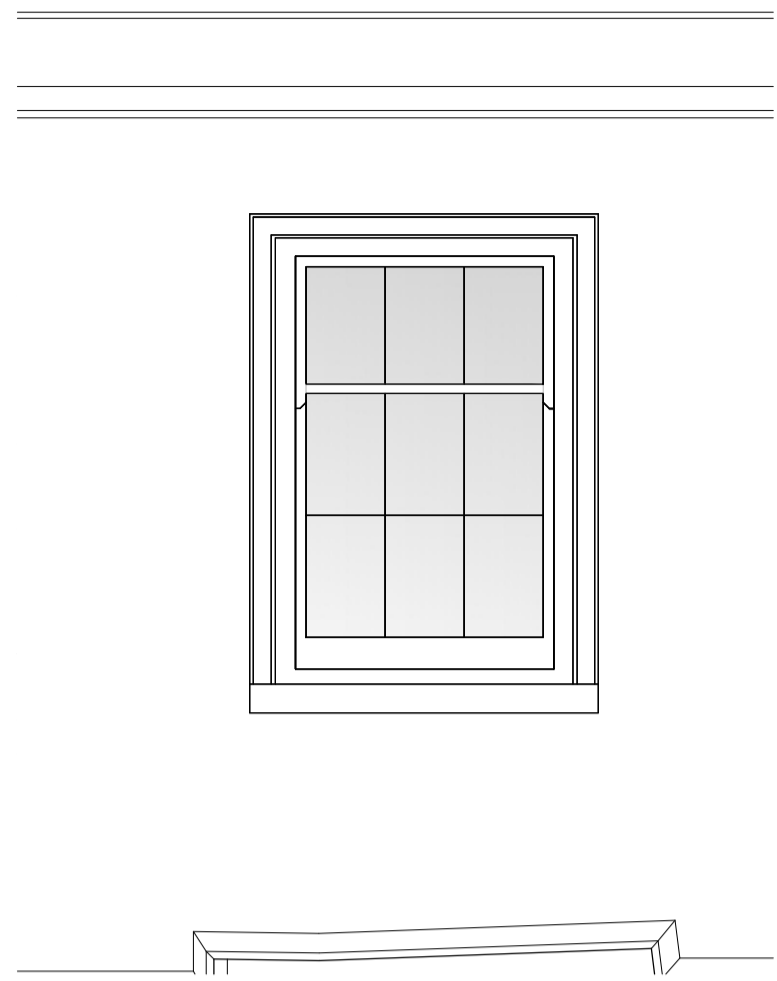

05 S04.W2
1:25@A1, 1:50@A3

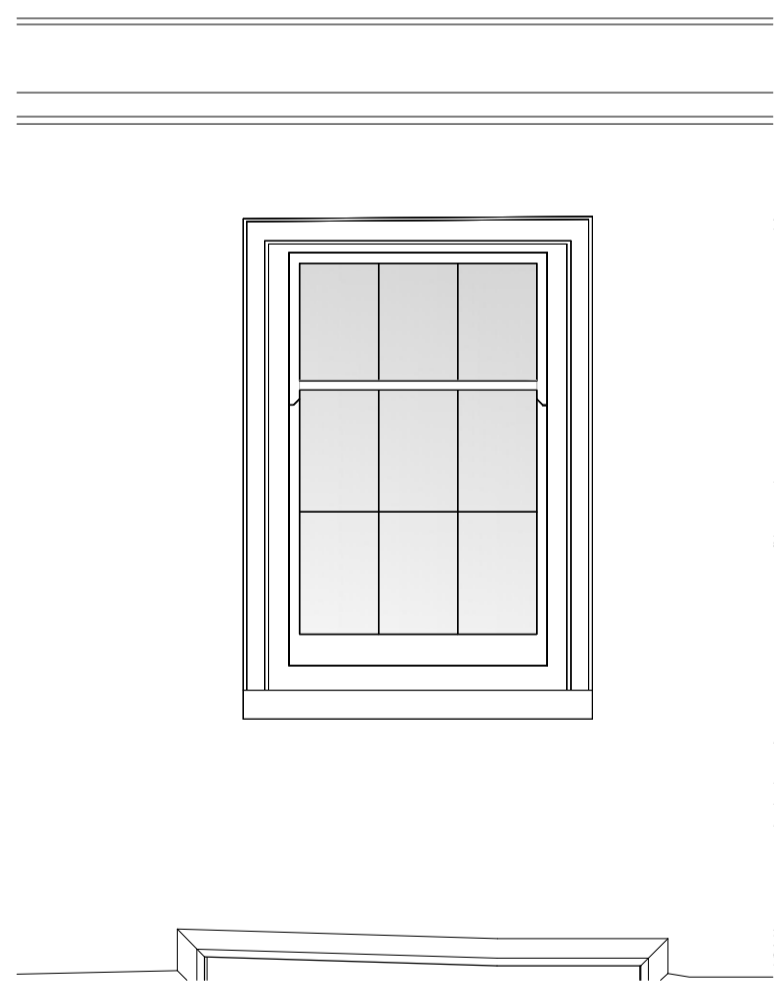

06 S05.W1
1:25@A1, 1:50@A3

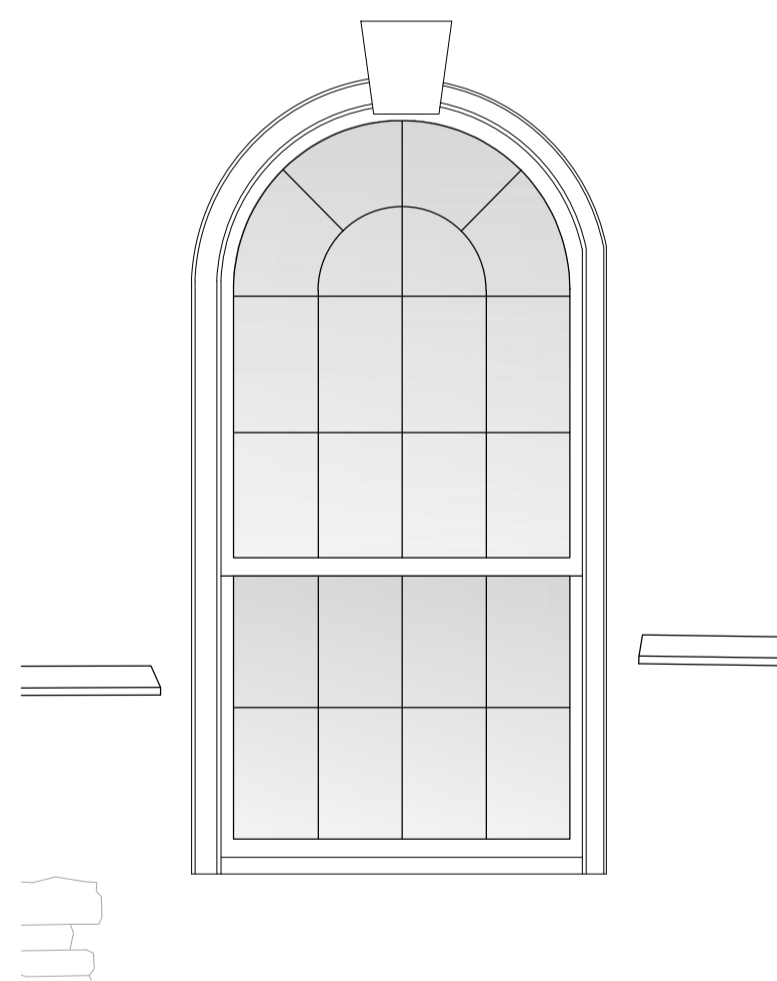

06 S01.W1
1:25@A1, 1:50@A3

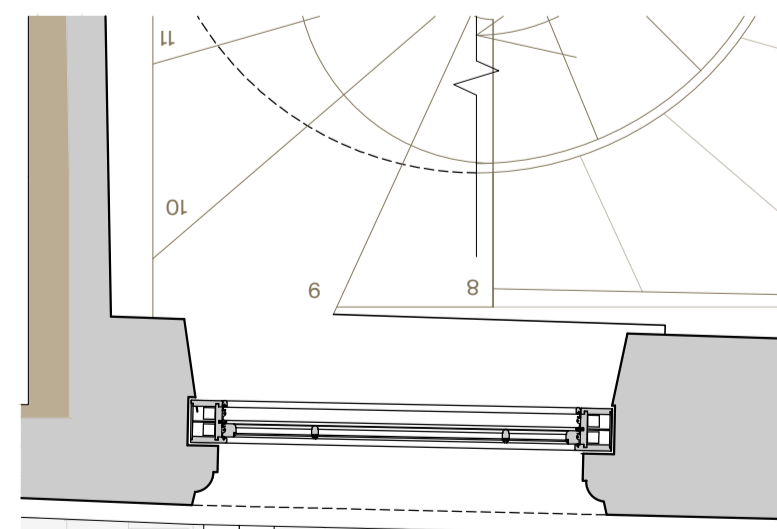
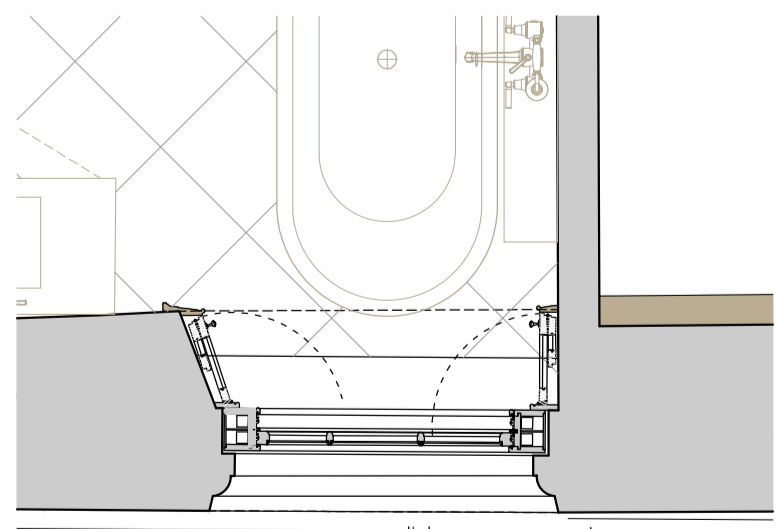

This drawing is to be used for planning purposes only.
Not for construction.

This drawing is the property of Richard Parr Associates.
Copyright is reserved by them and the drawing is issued
on the condition that it is not copied, reproduced,
retained or disclosed to any unauthorised person, either
wholly or in part without written consent.

© Copyright Richard Parr Associates

Checked by

Drawn by

Date

Description

Rev

Job No

315

Project

West Bradley House

Title

Proposed Second Floor Window
Schedule

Dwg No

315-MH-00-324

Scale

1:25@A1, 1:50@A3

Date of First Issue

March 2024

Status

Planning



**RICHARD PARR
ASSOCIATES**

studio@richardparr.com
+44 (0)1453 860200
richardparr.com
@richardparrassociates

+
COUNTRY
Easter Park
Nympsfield, Stonehouse
Gloucestershire GL10 3UL

TOWN
The People's Hall
Studio 5, 2 Olaf Street
London W11 4BE