

Document Name: Existing items 1,2,3
 Issue Date: 15 March 2024
 Document Version: 1.0

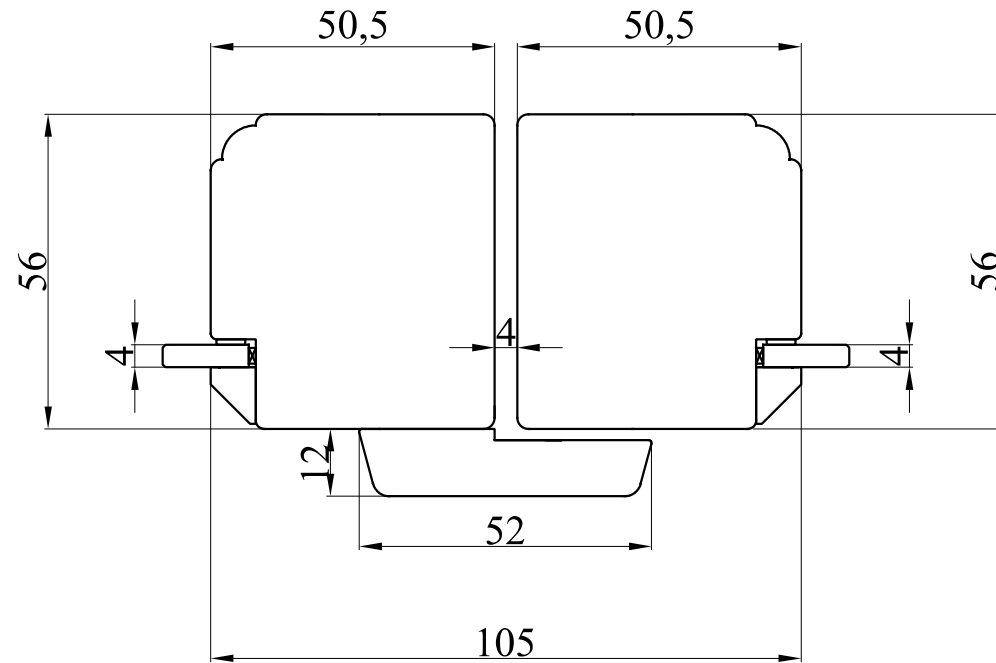

Project	T1843 Papadakos	OUTSIDE VIEW	
Order	O2400977	Quantity	1
Profile	INDIVIDUAL PROJECT	Technologist	MP
		Data	



Document Name: Existing meeting stiles detail of items 1,2,3
Issue Date: 15 March 2024
Document Version: 1.0



Project	T1843 Papadakos	OUTSIDE VIEW	
Order	O2400977	Quantity	1
		Technologist	MP
Profile	INDIVIDUAL PROJECT	Data	

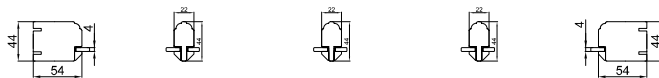
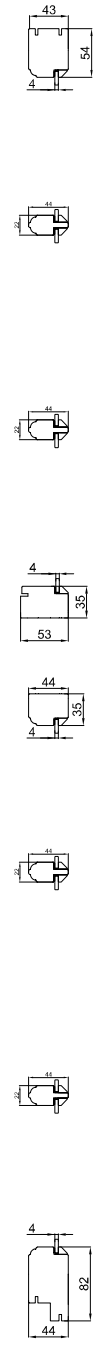
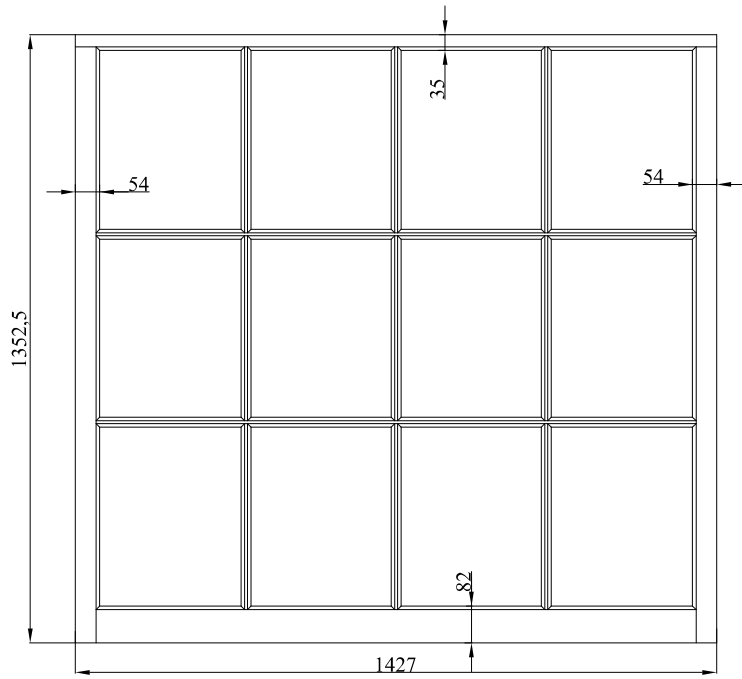
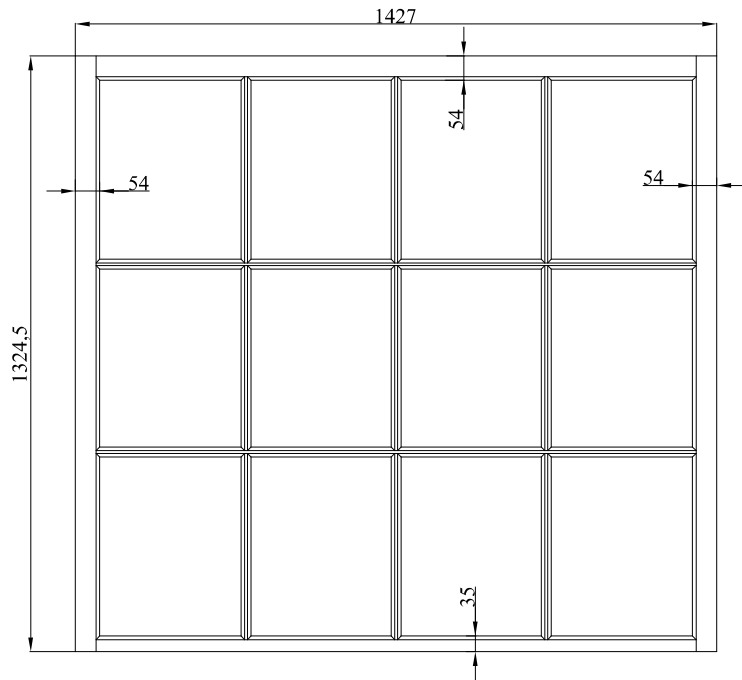

Document Name: Existing typical top and bottom sash detail of item 4
 Issue Date: 15 March 2024
 Document Version: 1.0



Project	T1843 Papadakos	OUTSIDE VIEW	
Order	O2400977	Quantity	1
ITEM		Technologist	MP
Profile	CWS_44 - IMITATION PUTTY		

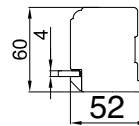
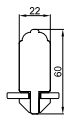
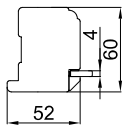
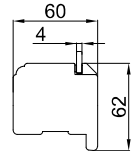
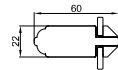
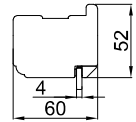
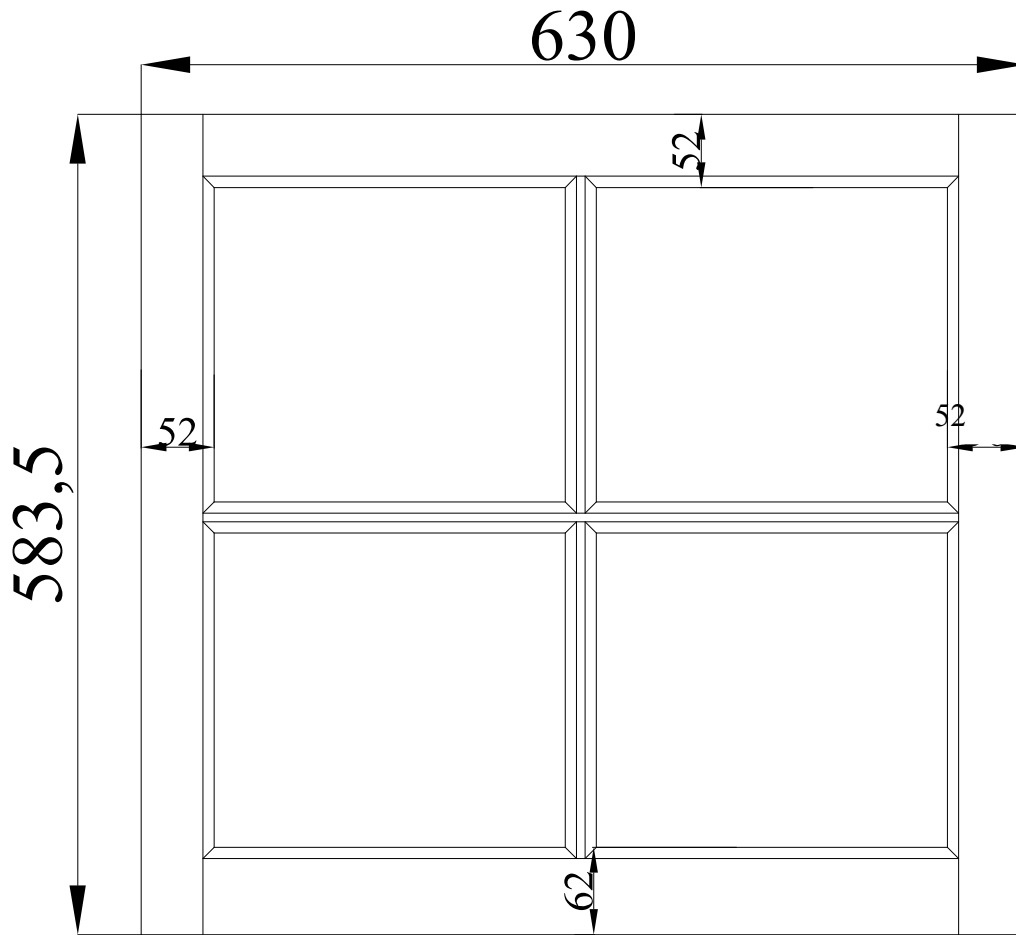

Document Name: Existing typical top sash detail of items 5,6,7,8
 Issue Date: 15 March 2024
 Document Version: 1.0



Project	T1843 Papadakos	OUTSIDE VIEW	
Order	O2400977	Quantity	1
		Technologist	MP
Profile	CAS_ISD - IMITATION PUTTY		

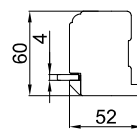
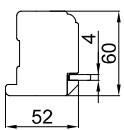
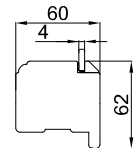
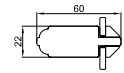
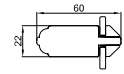
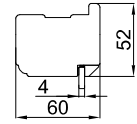
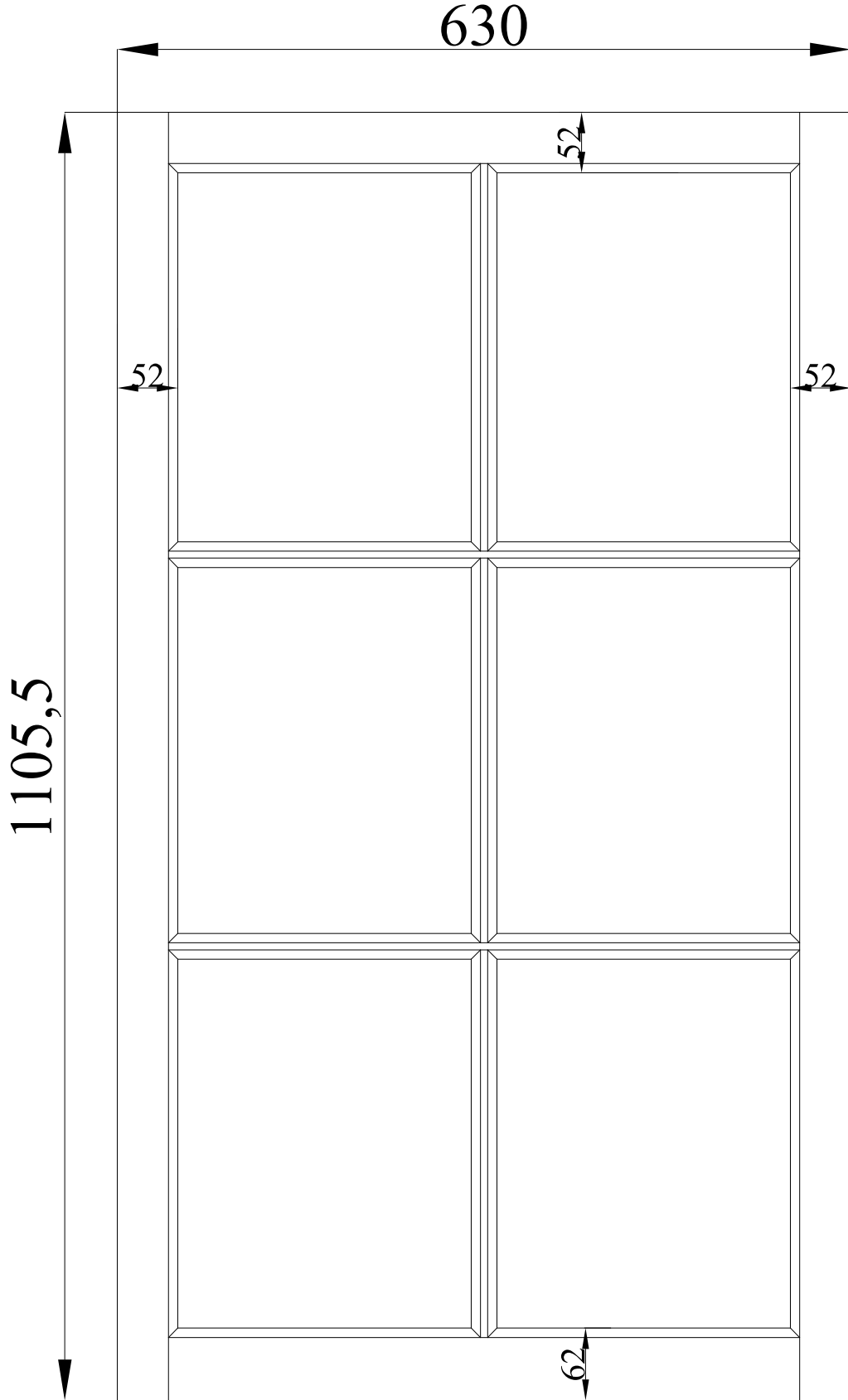

Document Name: Exsiting typical
 bottom sash detail of items 5,6,7,8
 Issue Date: 15 March 2024
 Document Version: 1.0

Project	T1843 Papadakos	OUTSIDE VIEW	
Order	O2400977	Quantity	1
ITEM		Technologist	MP
Profile	CAS_ISD - IMITATION PUTTY		