

GASKET SCHEGEL QL3004

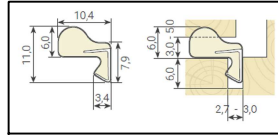

GASKET DEVENTER S 7672

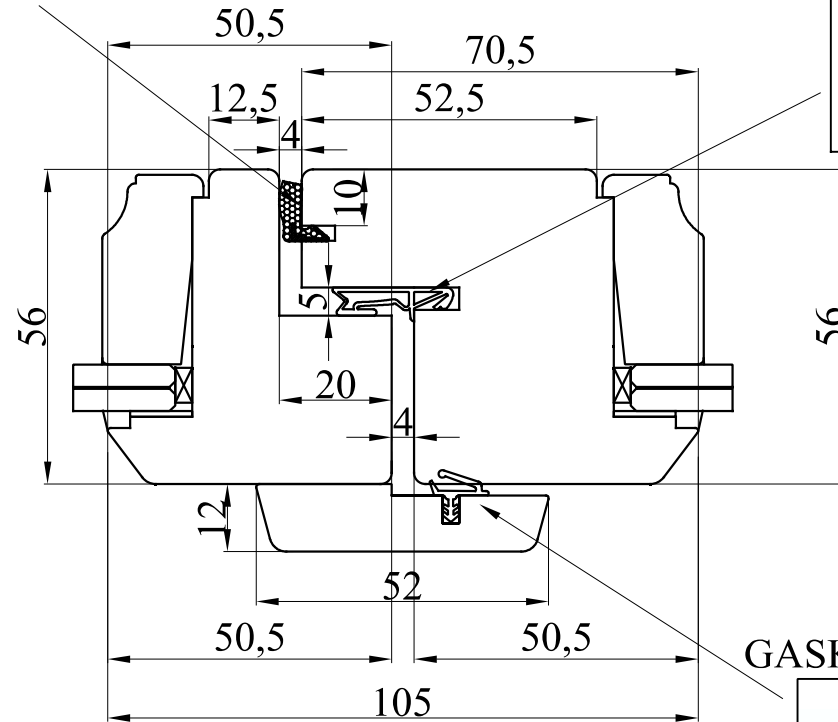
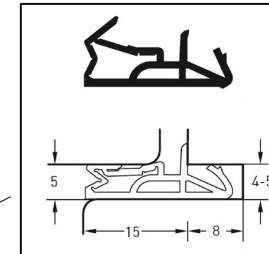

GASKET DEVENTER S 7624

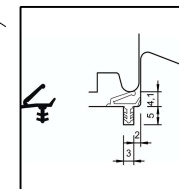

Document Name: Proposed meeting stiles detail of items 1,2,3

Issue Date: 24 April 2024

Document Version: 2.0



Project	T1843 Papadakos	OUTSIDE VIEW	
Order	O2400977	Quantity	1
		Technologist	MP
Profile	INDIVIDUAL PROJECT	Data	

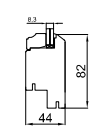
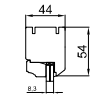
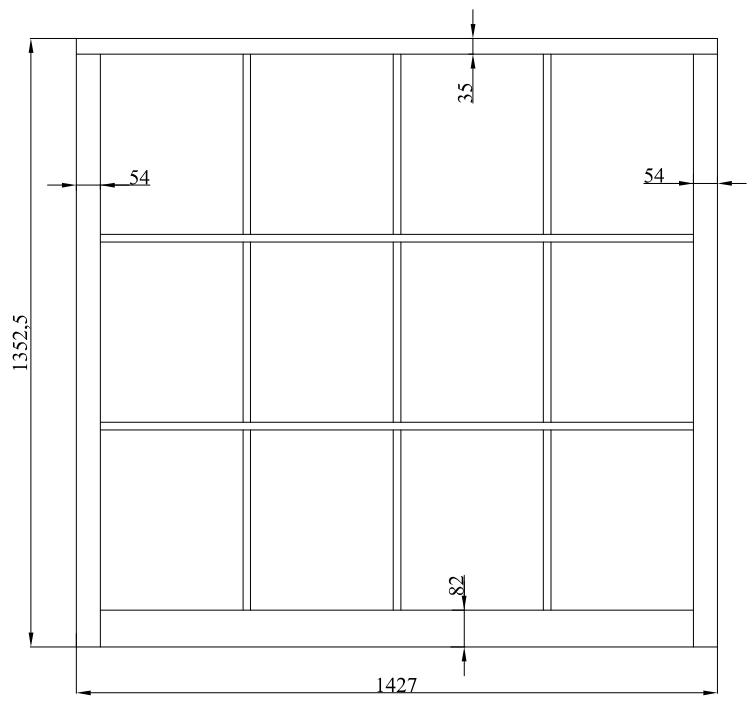
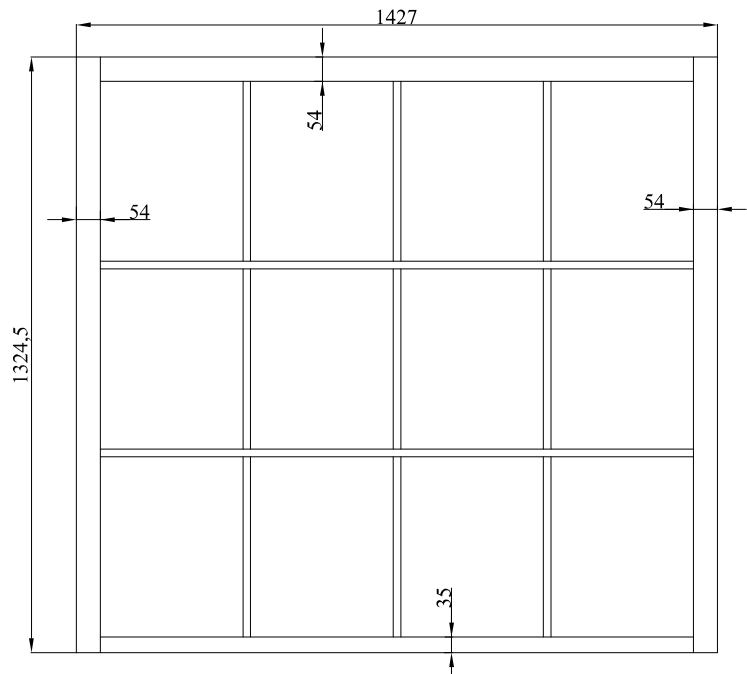

Document Name: Proposed typical top and bottom sash detail of item 4
Issue Date: 24 April 2024
Document Version: 2.0



Project	T1843 Papadakos	OUTSIDE VIEW	
Order	O2400977	Quantity	1
ITEM		Technologist	MP
Profile	CWS_44		

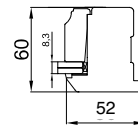
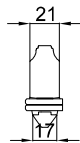
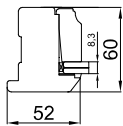
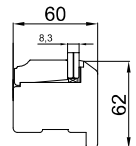
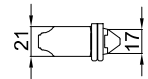
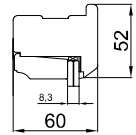
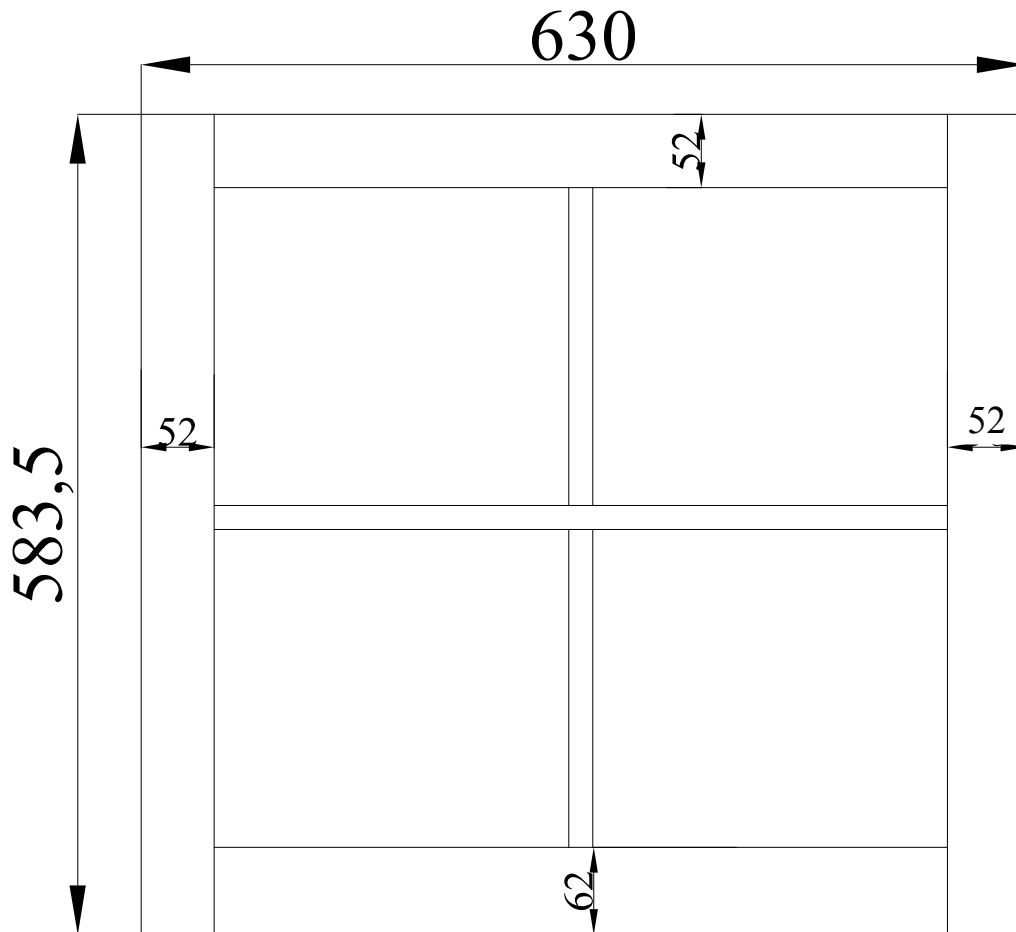

Document Name: Proposed typical top sash detail of items 5,6,7,8 - note glazing bar configuration differs per item.

Issue Date: 24 April 2024

Document Version: 2.0



Project	T1843 Papadakos	OUTSIDE VIEW	
Order	O2400977	Quantity	1
		Technologist	MP
Profile	CAS_ISD		

1105,5

630

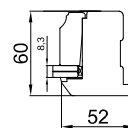
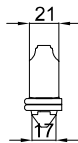
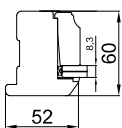
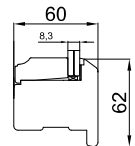
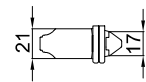
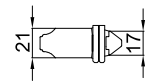
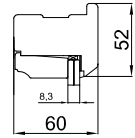
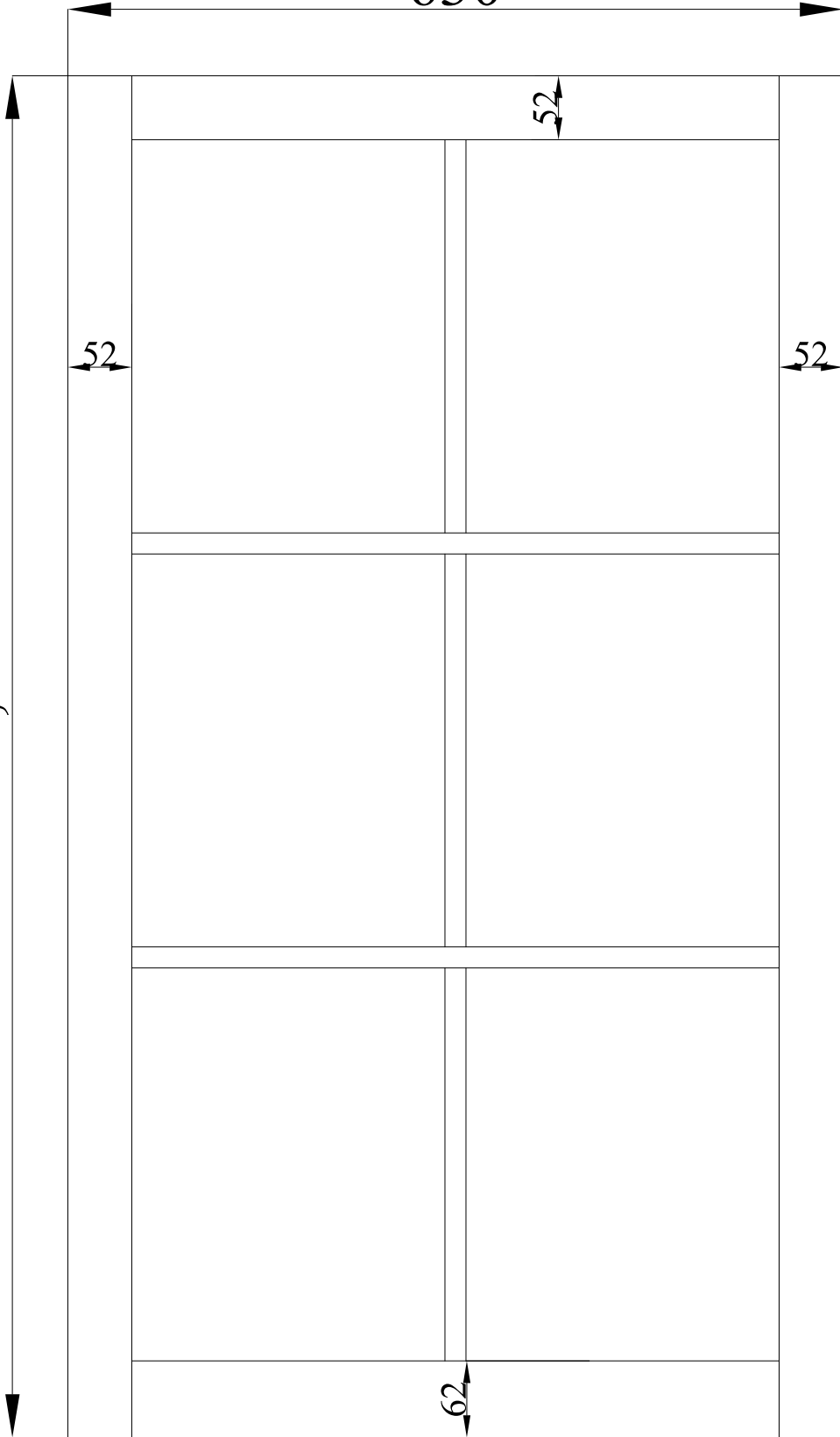

Document Name: Proposed typical bottom sash detail of items 5,6,7,8 note glazing bar configuration differs per item.
Issue Date: 15 March 2024
Document Version: 1.0



Project	T1843 Papadakos	OUTSIDE VIEW	
Order	O2400977	Quantity	1
ITEM		Technologist	MP
Profile	CAS_ISD		