

Document Name: Existing stiles and rails detail of items 1,2,3
 Issue Date: 30 April 2024
 Document Version: 2.0

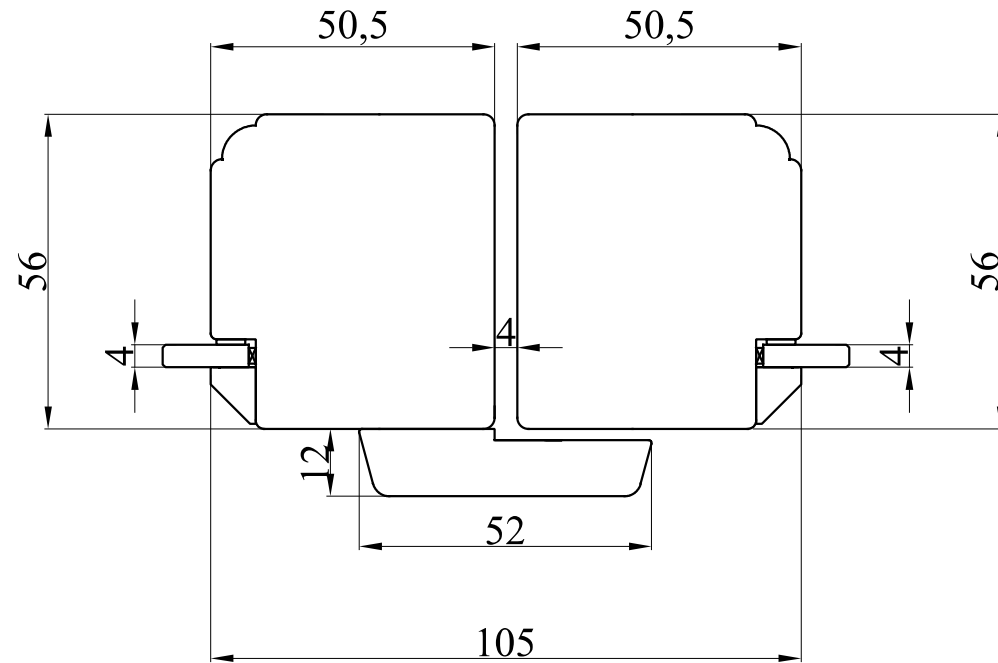

Project	T1843 Papadakos	OUTSIDE VIEW	
Order	O2400977	Quantity	1
		Technologist	MP
Profile	INDIVIDUAL PROJECT	Data	



Document Name: Existing meeting stiles detail of items 1,2,3
 Issue Date: 30 April 2024
 Document Version: 2.0



Project	T1843 Papadakos	OUTSIDE VIEW	
Order	O2400977	Quantity	1
		Technologist	MP
Profile	INDIVIDUAL PROJECT	Data	

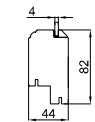
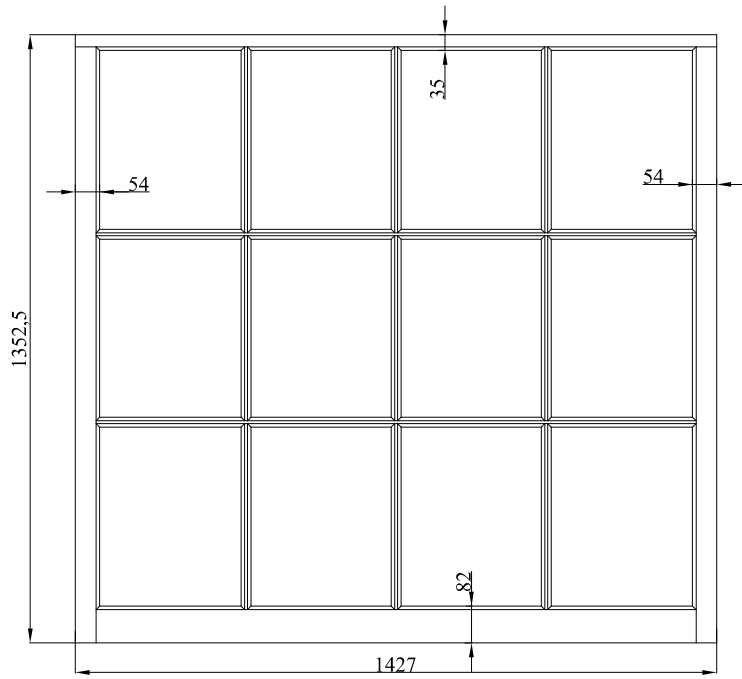
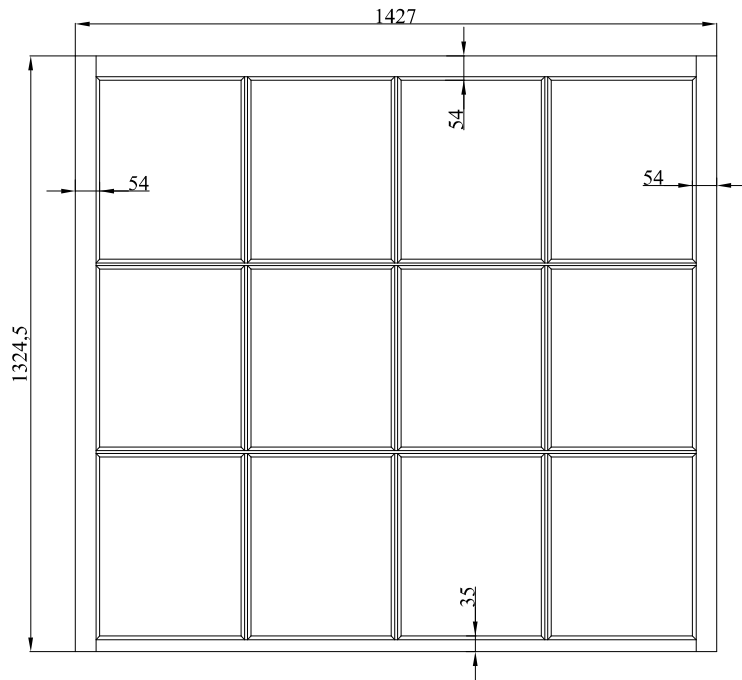

Document Name: Existing typical top and bottom sash detail of item 4
 Issue Date: 30 April 2024
 Document Version: 2.0



Project	T1843 Papadakos	OUTSIDE VIEW	
Order	O2400977	Quantity	1
ITEM		Technologist	MP
Profile	CWS_44 - IMITATION PUTTY		

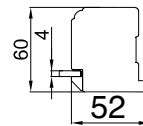
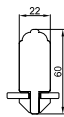
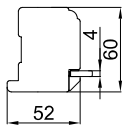
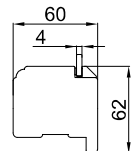
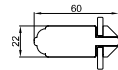
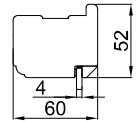
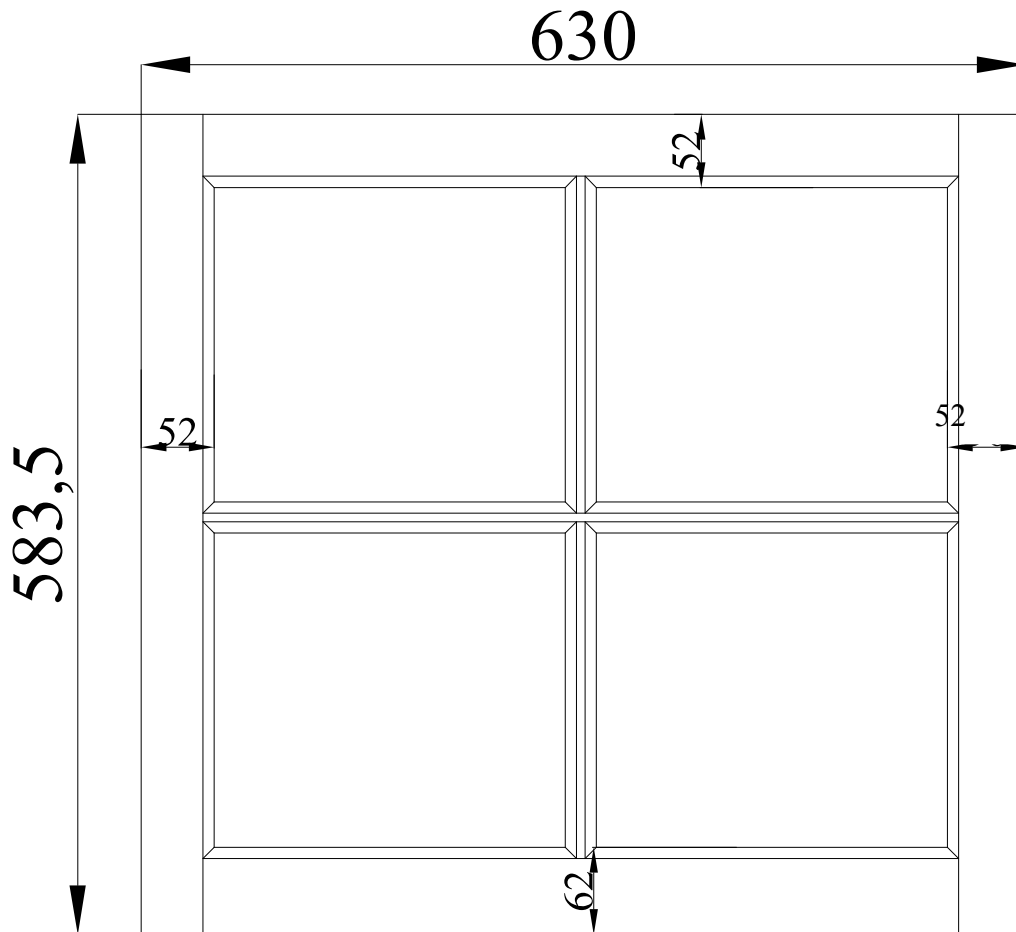

Document Name: Existing typical top sash detail of items 5-8, note glazing bar configuration changes depending on item.
Issue Date: 30 April 2024 Document Version: 2.0



Project	T1843 Papadakos	OUTSIDE VIEW	
Order	O2400977	Quantity	1
		Technologist	MP
Profile	CAS_ISD - IMITATION PUTTY		

1105,5

630

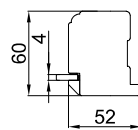
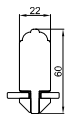
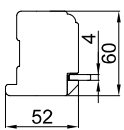
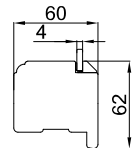
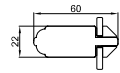
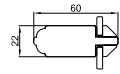
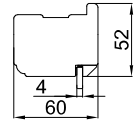
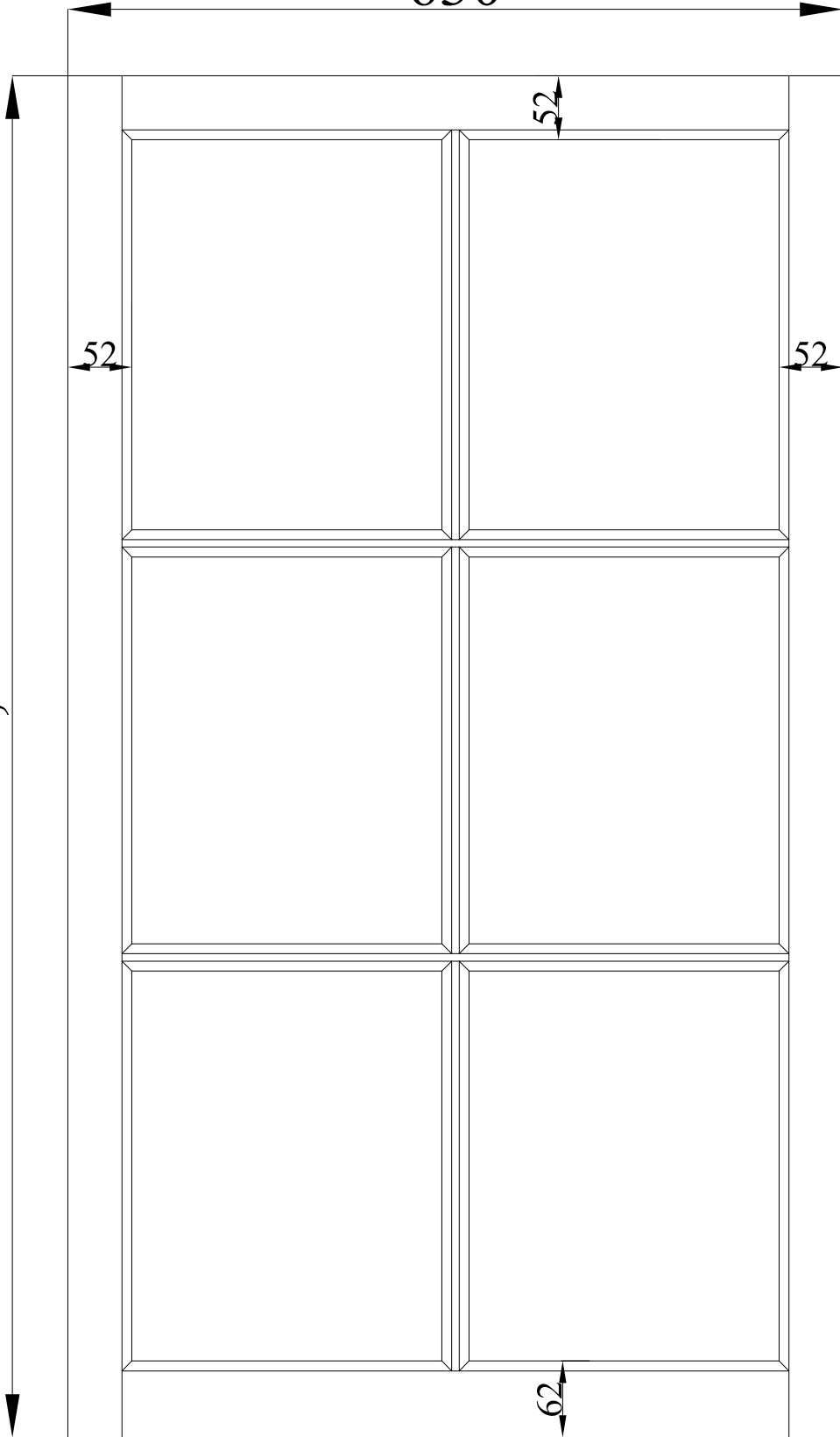

Document Name: Exsiting typical bottom sash detail of items 5,6,7,8 - Note glazing bar configuration differs per item. Issue Date: 30 April 2024 Document Version: 2.0

Project	T1843 Papadakos	OUTSIDE VIEW	
Order	O2400977	Quantity	1
ITEM		Technologist	MP
Profile	CAS_ISD - IMITATION PUTTY		