



# Continuous Line Acoustic Louvres

---



# Our new & exclusive 'Continuous Line' Acoustic Louvre system

The unique and modular design maintains a 'continuous line' appeal that's easy to assemble with our optional integrated steel work support system.

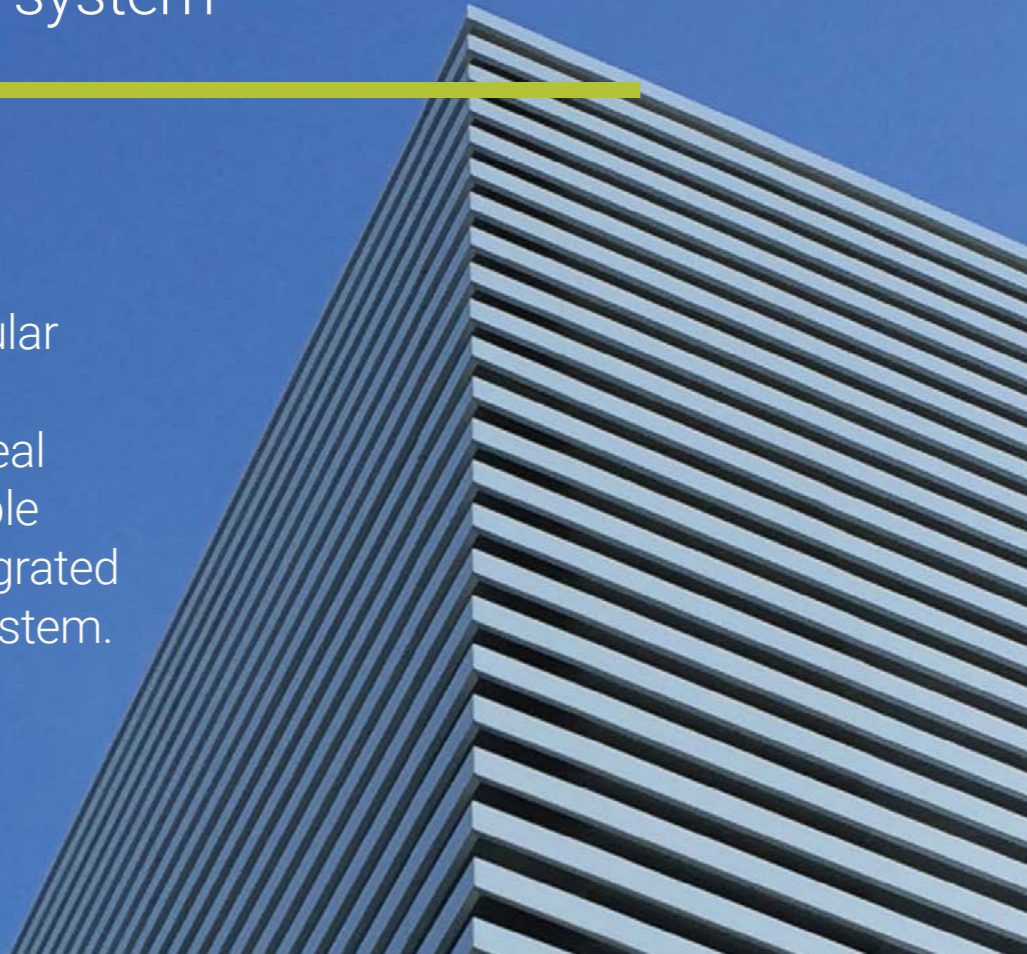

## One multi-purpose system with many applications

Acoustic Louvre applications include: fresh air intakes and exhausts for ventilation systems, mechanical equipment screens or enclosures, natural ventilation and façade cladding, all providing a seamless look wherever they are used.

For a totally individual appearance, the Acoustic Louvres are fabricated from galvanised steel and can be finished in polyester powder paint to a wide range of RAL colours.



## You can be confident in our performance testing

We like to do things properly and our Acoustic Louvre range has therefore been rigorously tested to offer performance data that you can trust. Applicable standards are -

- Sound Reduction BS EN ISO 10140-2: 2010 (SRL)
  - Insertion Loss and Pressure Loss BS EN ISO 7235: 2009 (LCP)
  - Rainwater Penetration BS EN ISO 13030: 2001 (BSRIA)
- More details on these test standards are available upon request.

## Class A rainwater penetration

Rainwater will penetrate into a building through standard Acoustic Louvres. So we have developed a unique rainwater rejection system that can be fitted to the rear of the Acoustic Louvres to achieve Class A rainwater penetration when tested at BSRIA (99% effective at 1m/s face velocity).

## Visually attractive and versatile

With our Continuous Line Acoustic Louvres you can achieve a similar visual appearance to Continuous Line Weather Louvres. A range of sound reduction performance options are then available to suit your particular requirements including Attenuators mounted at the rear for even greater performance.

Being the largest company in the UK that manufactures Continuous Line Acoustic Louvres, Continuous Line Weather Louvres and Attenuators in-house we will recommend the best performing and most cost efficient solution for your project.

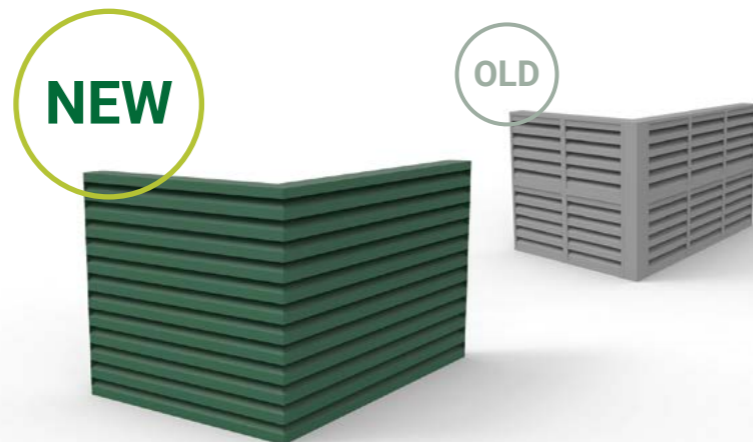

Contemporary looks, enhanced by improved performance. We are proud to be leading edge.

## Built with designers and architects in mind

### CASE STUDY

## Infinity Here East Data Centre (previously the Olympic Media Centre)

East London

We designed, supplied and installed £2.69m worth of SS150 Acoustic Louvres and support steelwork as a façade to protect residential neighbours from plant noise emissions from this new data centre.

Full article available.



## Supporting you every step of the way

---

We are always delighted to answer your questions and provide you with detailed specifications, acoustic design and pricing. If you have a complex project then we can develop products or design solutions to meet your specialist needs with our bespoke service.



Partner with **experts who understand you and your market**

---

### Beautifully designed

All our contracts are drawn by skilled technicians, using AutoDesk Inventor, building accurate 3D models of the products, so all elements fit perfectly with each other and your building.

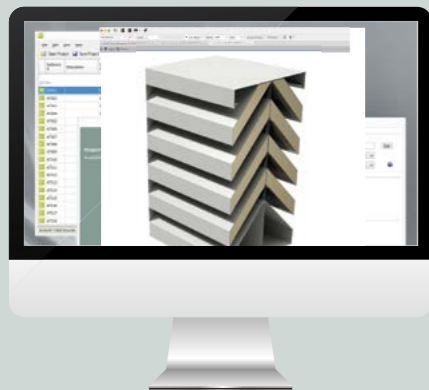

### Continuous investment in automated manufacturing

Advanced technology is central to our Production facilities in Dorset. From automated laser profiling and folding of sheet metal parts to high quality polyester powder painting for a durable and long lasting finish. We hate waste of all kinds and so continuously drive them out. Guaranteeing you the highest quality products, achieving your expectations and all delivered at the lowest possible cost.

### Accurate installation, on time and budget

Our highly trained project managers will work with you to ensure our products are installed on time and to budget, even for the most challenging of projects.

The unique modular design of our Acoustic Louvres makes installation faster, helping to save vital time on site.

We have even designed an innovative front fix bracket system for situations where the louvres can only be installed from the front.

**5%**

Material waste is down below 5% thanks to our unique software. All unused steel is recycled

# Acoustic Louvre applications

Our acousticians will recommend the best solution for your project based on your specific application and requirements. Whether natural or mechanical ventilation is required, what demand there is for sound reduction and if unsightly buildings or plant need 'hiding' from view.

The geographical location and height above sea level will also determine exposure to weather and wildlife which may require added protection.

Whatever your challenges, we'll have you covered.

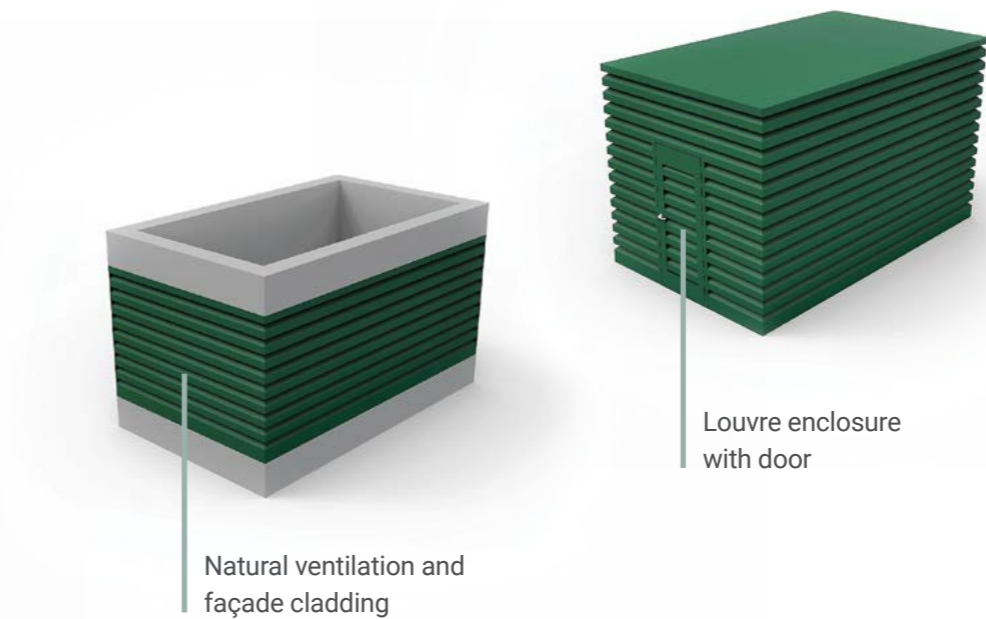
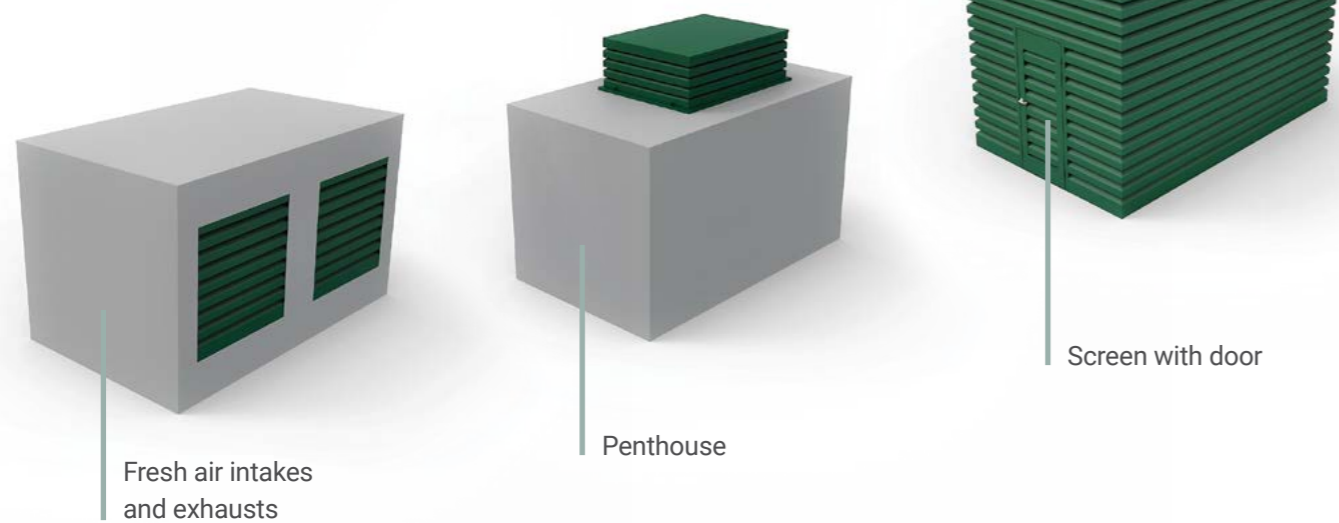

## UKCA and CE marked Acoustic Louvre doors

As well as being a legal requirement, your wellbeing and safety is important to us so our doors are both UKCA and CE marked. Doors are available as both single and double leaf. There's an extensive range of furniture options to meet both your safety and security requirements. They are offered for active airflow or provided as dummy profiles with blanking.



**We're pioneers.** Partnering with you to lead our industry, by creating the best products and structuring our business around you. Sharing our knowledge, embracing new ways of working using the latest technologies and being careful of our environment.

**Nobody likes noisy neighbours.**  
Reduce noise levels with our acoustically treated louvre systems

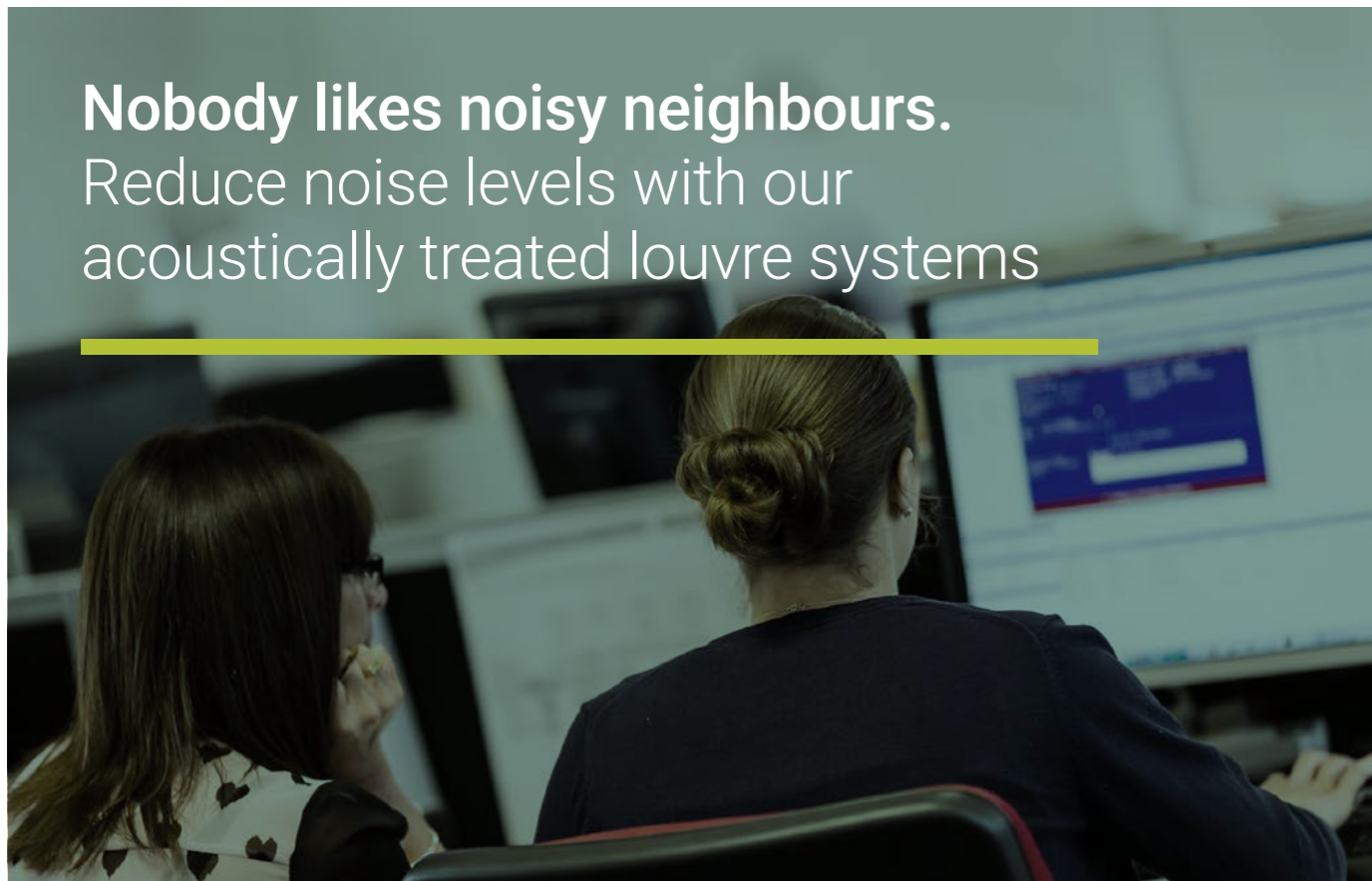

## Sound reduction comparison chart

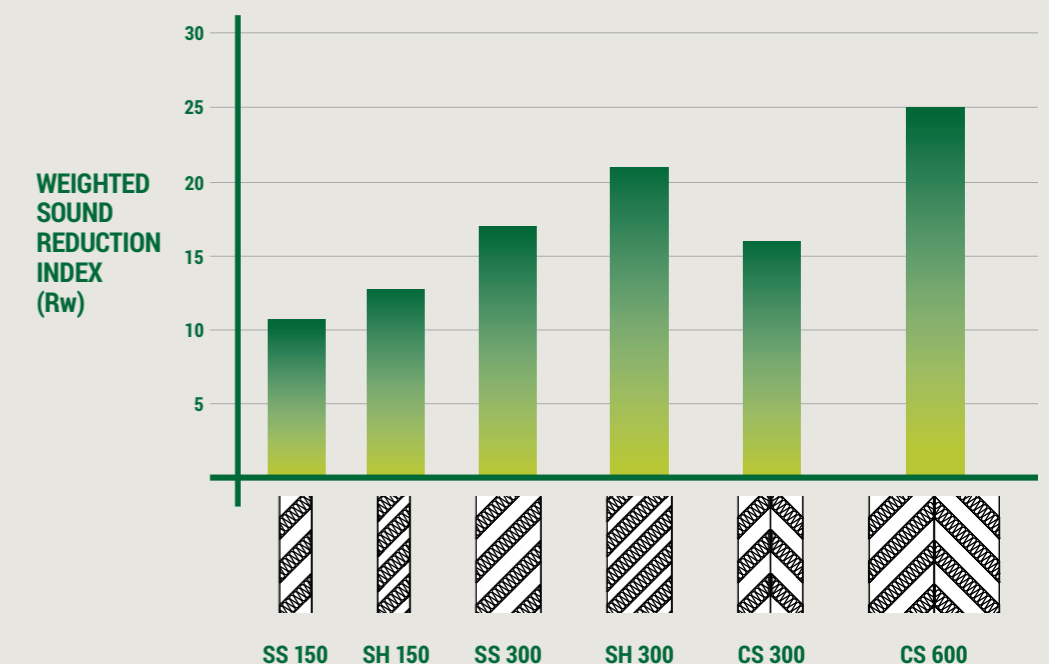

# Acoustic Louvre options

## 1 A wide range of performance options available

Six different models are available with varying degrees of sound reduction performance using Acoustic Louvre depths of 150mm, 300mm and 600mm. Two models of matching 150mm deep Dummy Acoustic Louvres can also be provided with acoustic blanking at the rear where air movement is not required.

## 2 Optional panels fitted behind the Acoustic Louvres

These options will make your building work better and help to match your specific requirements.

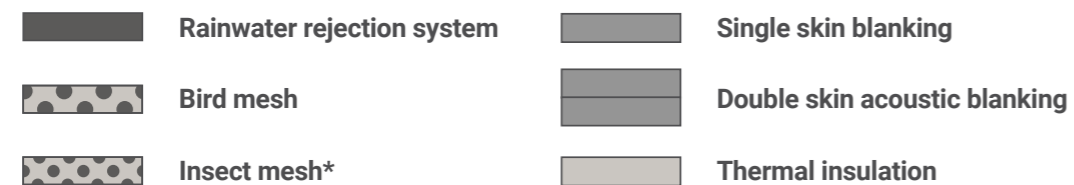

\* Please contact Caice to ensure the correct application of Insect mesh

## 3 Steelwork support system

We have developed a steelwork support system that can be fully integrated into our design to enable easy installation of Acoustic Louvres for screening applications, enclosures or within large building apertures. Calculations can be provided to ensure structural and wind loading requirements are achieved.

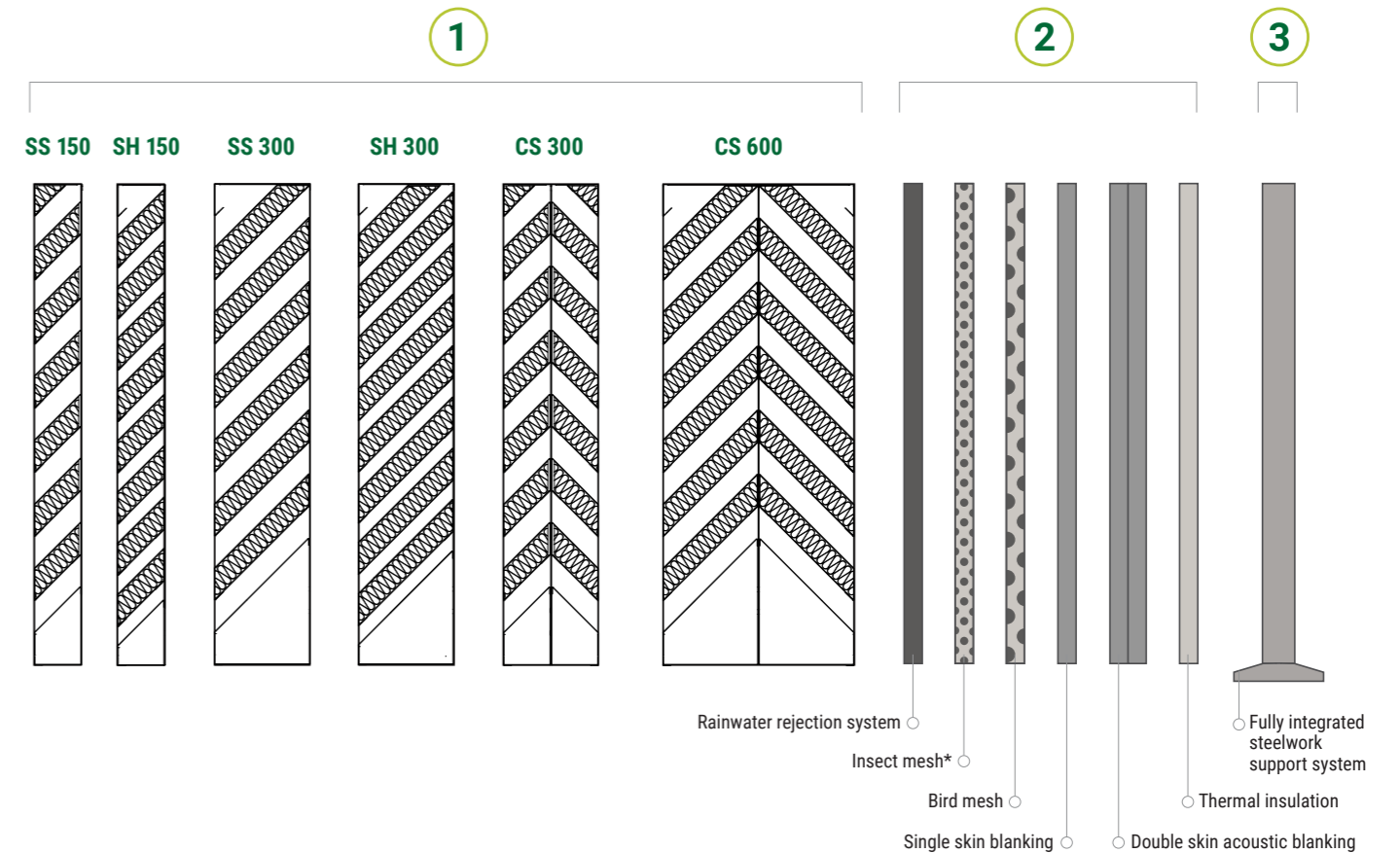

### CASE STUDY

## Cornwall Energy Recovery Centre (CERC)

St Austell, Cornwall.

We designed a completely new Acoustic Louvre to meet the Class A rainwater penetration requirements for this exposed project near the coast.

High winds and working through the winter also made installation challenging at 50 metres above the ground. Yet it was completed safely and on time with special scissor lifts externally and abseilers inside.

Full article available.



# Acoustic Louvre Product Code Definitions

## Product

**AL**

### Acoustic Louvre

#### Type

<b>SS150</b>	Single bank standard profile 150 deep
<b>SH150</b>	Single bank high performance profile (reduced airway) 150 deep
<b>SS300</b>	Single bank standard profile 300 deep
<b>SH300</b>	Single bank high performance profile (reduced airway) 300 deep
<b>CS300</b>	Chevron standard profile 300 Deep
<b>CS600</b>	Chevron standard profile 600 Deep
<b>DS150</b>	Dummy single bank standard profile 150 deep
<b>DH150</b>	Dummy single bank high performance profile 150 deep

#### Material

<b>G</b>	Galvanised Steel
----------	------------------



#### Format

<b>M</b>	Modular
<b>S</b>	Single door (on its own) UKCA & CE marked
<b>D</b>	Double door (on its own) UKCA & CE marked
<b>P</b>	Penthouse with roof
<b>Suffix NT</b>	Blades In normal orientation, set out from top

## Options

### Integral Doors UKCA & CE marked (where n= number off)

<b>SOn</b>	Integral single leaf door outward opening
<b>DOn</b>	Integral double leaf door outward opening

### Flashing

<b>T1</b>	External picture frame
<b>T2</b>	Weather cill

### Penetration (where n= number off)

<b>Pn</b>	Rectangular penetration
-----------	-------------------------

### Removable (where n= number off)

<b>Rn</b>	Removable modules
-----------	-------------------

### Fixings

<b>F3</b>	Aperture fixing brackets
<b>F4</b>	Front fix brackets
<b>J1</b>	Back joining brackets

### Other

<b>H1</b>	Standard door hardware
<b>H2</b>	Emergency exit door hardware
<b>X</b>	Special

### Delivery

<b>001-999</b>	Number of items delivered to site
<b>Suffix P</b>	Protective packaging
<b>Suffix H</b>	Protective packaging heat treated pallet



#### Finish

<b>U</b>	Unfinished base material
<b>A</b>	Standard polyester powder paint
<b>B</b>	Premium polyester powder paint
<b>C</b>	Premium plus polyester powder paint
<b>Suffix E</b>	External louvre only finished (CS300 and CS600 only)
<b>Suffix W</b>	Whole product

#### Features

<b>A</b>	Class A rainwater rejection
<b>N</b>	No backing
<b>B</b>	Bird mesh
<b>I</b>	Insect mesh
<b>G</b>	Single skin blanking
<b>T</b>	Thermal insulation

# SS150 Acoustic Louvre Technical Data



## Single Bank Acoustic Louvre, Standard Performance Profile, 150mm Deep

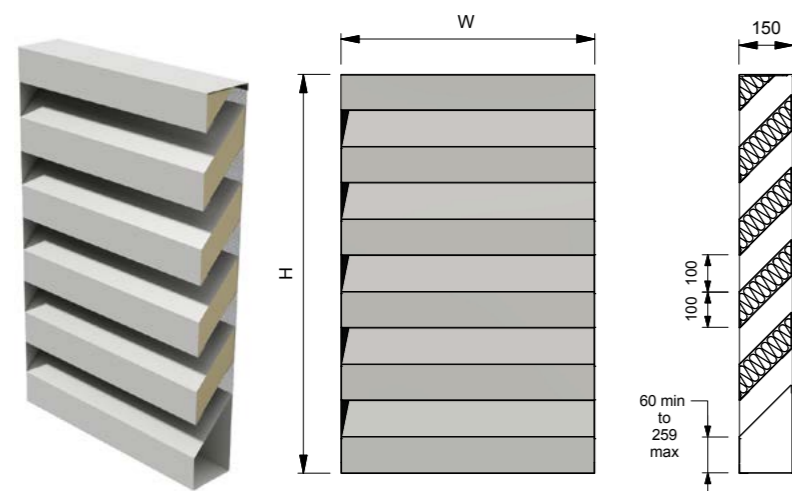

Typical weight 29kg/m<sup>2</sup>

Generally louvres above 50kg will be supplied in modules for assembly on site. Joining brackets and fixings will be provided for assembly.

Installation services, support steelwork, flashings, fixings to the structure and mastic will not be provided unless stated.

Refer to the Acoustic Louvre Schedule and Product Code Definitions for the size and specification of each Acoustic Louvre.

A minimum of 10mm clearance should be allowed between the structure and the Acoustic Louvre sizes shown.

## Performance

Acoustic Data	dB in each Octave Band Centre Frequency (Hz)							
	63	125	250	500	1k	2k	4k	8k
Sound reduction index	4	4	6	8	11	11	11	10
Weighted sound reduction index (Rw)	11							
Static insertion loss	3	4	6	10	12	13	13	14
Regenerated sound power level at 1m/s face velocity	48	41	34	35	30	22	13	12
Regenerated sound power level at 2m/s face velocity	66	58	51	51	50	47	41	28

## Free Area and Height range

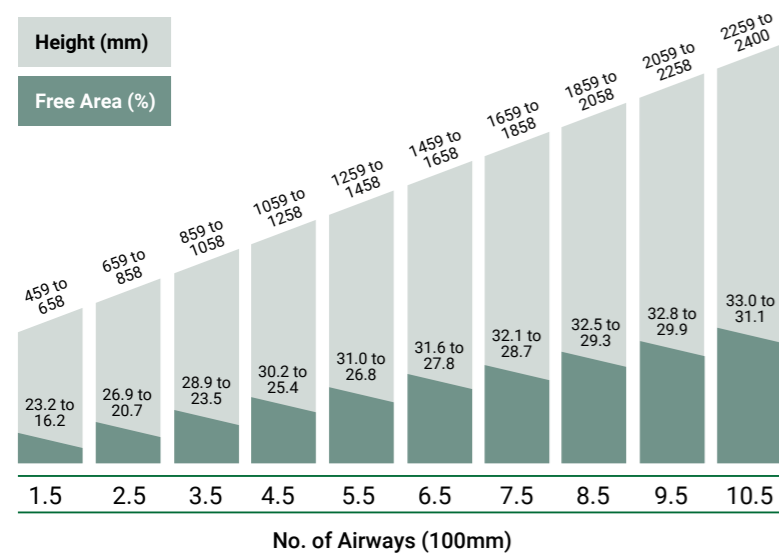

Free area and pressure drop shown is based on a 1150mm wide single piece louvre fitted with bird mesh and will vary slightly for different widths and larger heights. Pressure losses for Class A rated louvres and/or Insect mesh are available upon request.

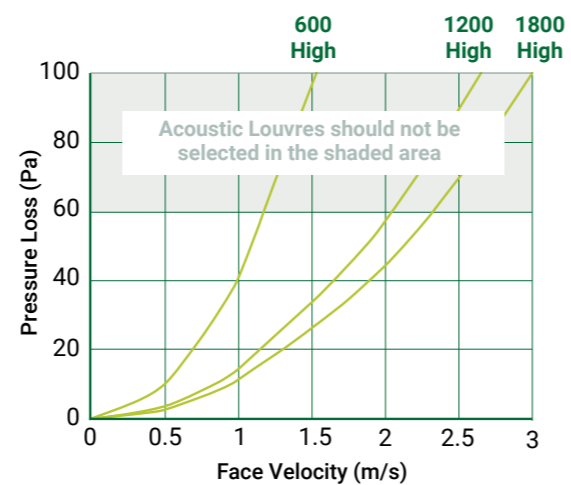

# SH150 Acoustic Louvre Technical Data



## Single Bank Acoustic Louvre, Higher Performance Profile, 150mm Deep

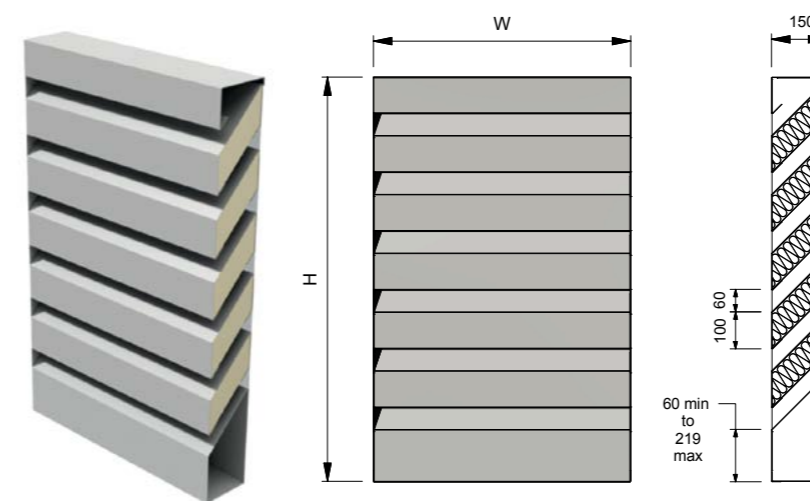

Typical weight 35kg/m<sup>2</sup>

Generally louvres above 50kg will be supplied in modules for assembly on site. Joining brackets and fixings will be provided for assembly.

Installation services, support steelwork, flashings, fixings to the structure and mastic will not be provided unless stated.

Refer to the Acoustic Louvre Schedule and Product Code Definitions for the size and specification of each Acoustic Louvre.

A minimum of 10mm clearance should be allowed between the structure and the Acoustic Louvre sizes shown.

## Performance

Acoustic Data	dB in each Octave Band Centre Frequency (Hz)							
	63	125	250	500	1k	2k	4k	8k
Sound reduction index	5	5	7	9	13	13	13	12
Weighted sound reduction index (Rw)	13							
Static insertion loss	4	5	7	12	16	16	16	18
Regenerated sound power level at 1m/s face velocity	53	47	38	36	33	29	18	12
Regenerated sound power level at 2m/s face velocity	70	65	58	53	51	51	45	35

## Free Area and Height range

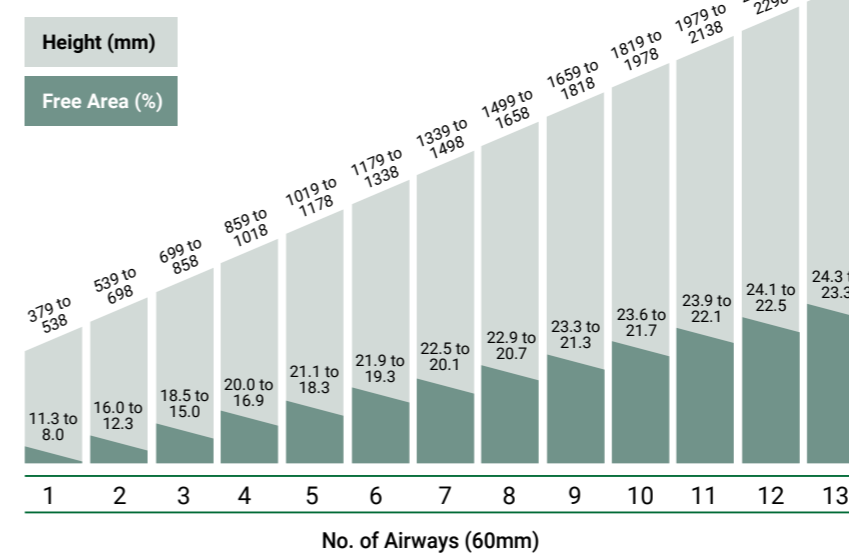

Free area and pressure drop shown is based on a 1150mm wide single piece louvre fitted with bird mesh and will vary slightly for different widths and larger heights. Pressure losses for Class A rated louvres and/or Insect mesh are available upon request.

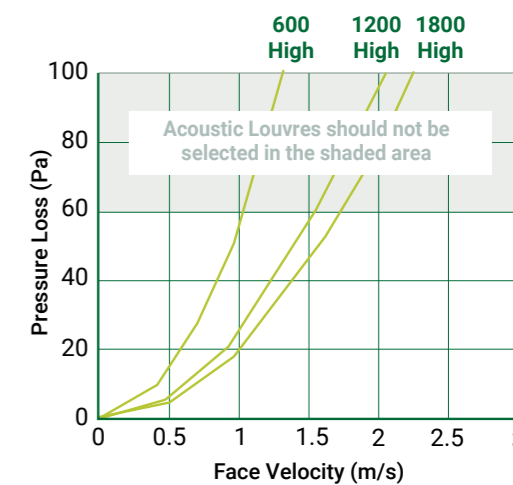

# SS300 Acoustic Louvre Technical Data



## Single Bank Acoustic Louvre, Standard Performance Profile, 300mm Deep

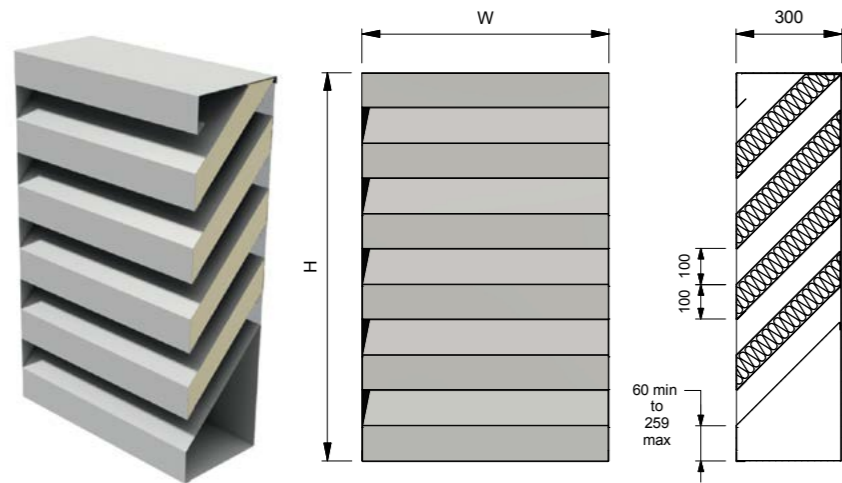

Typical weight 43kg/m<sup>2</sup>  
 Generally louvres above 50kg will be supplied in modules for assembly on site. Joining brackets and fixings will be provided for assembly.  
 Installation services, support steelwork, flashings, fixings to the structure and mastic will not be provided unless stated.  
 Refer to the Acoustic Louvre Schedule and Product Code Definitions for the size and specification of each Acoustic Louvre.  
 A minimum of 10mm clearance should be allowed between the structure and the Acoustic Louvre sizes shown.

## Performance

Acoustic Data	dB in each Octave Band Centre Frequency (Hz)							
	63	125	250	500	1k	2k	4k	8k
Sound reduction index	6	6	9	13	21	20	16	13
Weighted sound reduction index (Rw)	17							
Static insertion loss	5	6	9	14	20	20	20	20
Regenerated sound power level at 1m/s face velocity	48	41	34	30	25	20	13	12
Regenerated sound power level at 2m/s face velocity	66	58	51	47	45	43	39	28

## Free Area and Height range

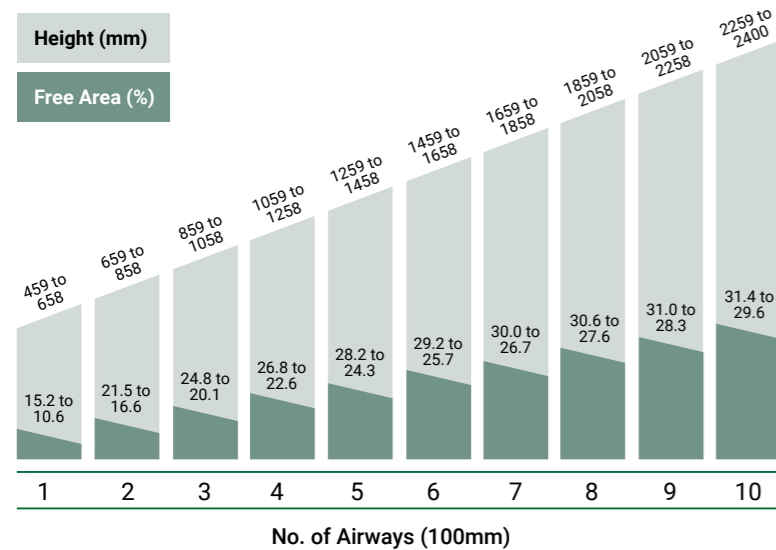

Free area and pressure drop shown is based on a 1150mm wide single piece louvre fitted with bird mesh and will vary slightly for different widths and larger heights. Pressure losses for Class A rated louvres and/or Insect mesh are available upon request.

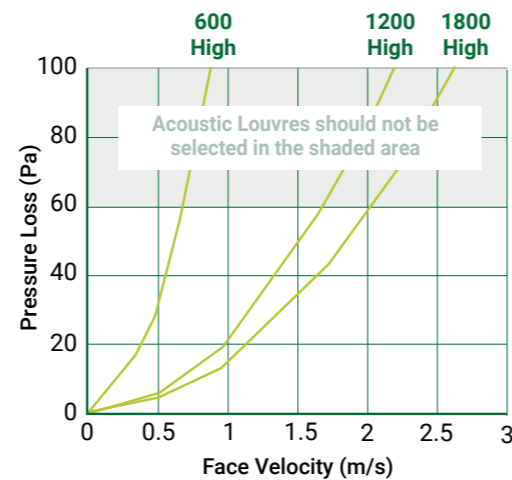

# SH300 Acoustic Louvre Technical Data



## Single Bank Acoustic Louvre, Higher Performance Profile, 300mm Deep

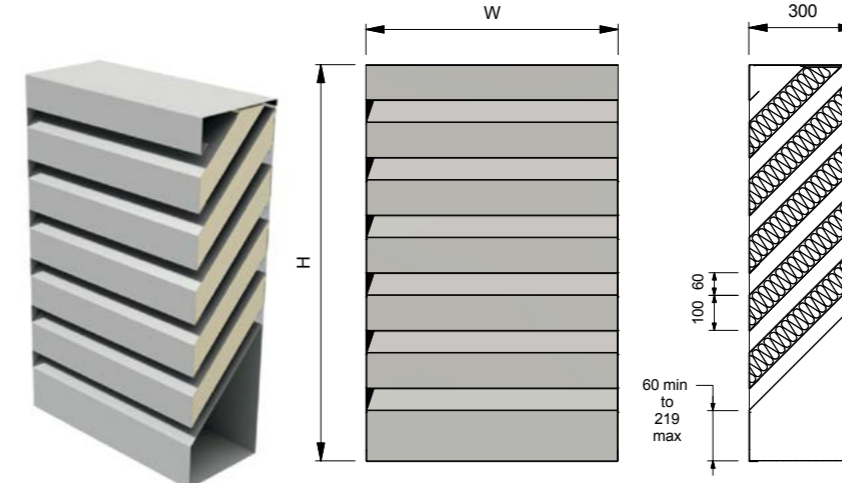

Typical weight 53kg/m<sup>2</sup>  
 Generally louvres above 50kg will be supplied in modules for assembly on site. Joining brackets and fixings will be provided for assembly.  
 Installation services, support steelwork, flashings, fixings to the structure and mastic will not be provided unless stated.  
 Refer to the Acoustic Louvre Schedule and Product Code Definitions for the size and specification of each Acoustic Louvre.  
 A minimum of 10mm clearance should be allowed between the structure and the Acoustic Louvre sizes shown.

## Performance

Acoustic Data	dB in each Octave Band Centre Frequency (Hz)							
	63	125	250	500	1k	2k	4k	8k
Sound reduction index	7	7	10	17	29	30	27	21
Weighted sound reduction index (Rw)	21							
Static insertion loss	6	7	10	18	31	28	26	25
Regenerated sound power level at 1m/s face velocity	50	44	39	34	30	26	17	12
Regenerated sound power level at 2m/s face velocity	70	60	55	52	49	49	43	35

## Free Area and Height range

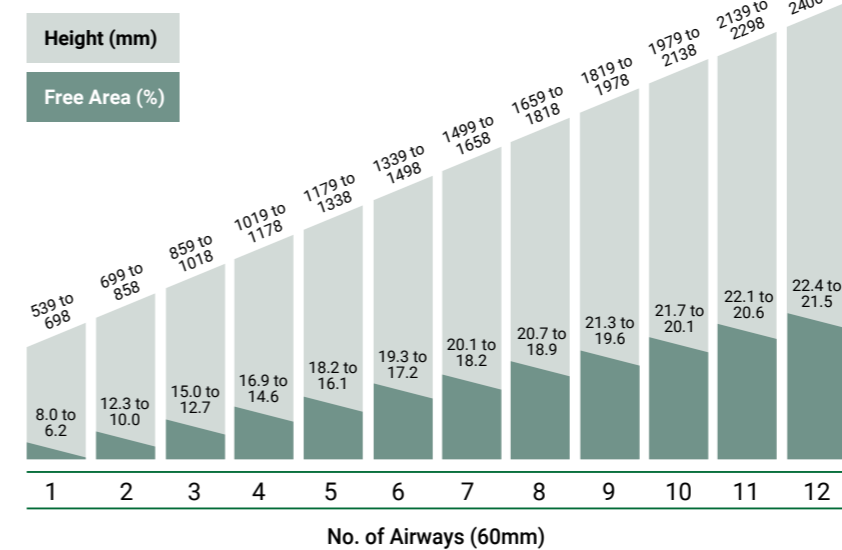

Free area and pressure drop shown is based on a 1150mm wide single piece louvre fitted with bird mesh and will vary slightly for different widths and larger heights. Pressure losses for Class A rated louvres and/or Insect mesh are available upon request.

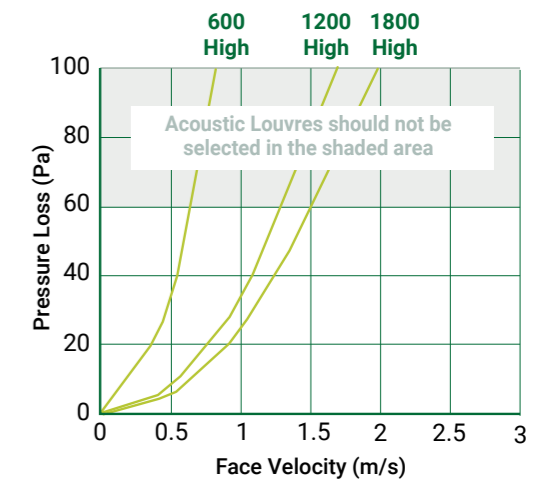



# CS300 Acoustic Louvre Technical Data



## Chevron Acoustic Louvre, Standard Performance Profile, 300mm Deep

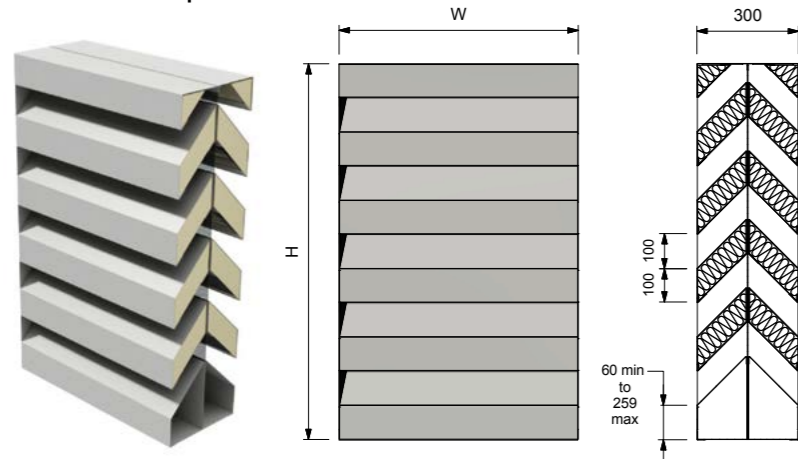

Typical weight 57kg/m<sup>2</sup>

Generally louvres above 50kg will be supplied in modules for assembly on site. Joining brackets and fixings will be provided for assembly.

Installation services, support steelwork, flashings, fixings to the structure and mastic will not be provided unless stated.

Refer to the Acoustic Louvre Schedule and Product Code Definitions for the size and specification of each Acoustic Louvre.

A minimum of 10mm clearance should be allowed between the structure and the Acoustic Louvre sizes shown.

Site constraints may make the installation of the Chevron style product impractical. Please contact Caice to discuss your requirements before selecting.

## Performance

Acoustic Data	dB in each Octave Band Centre Frequency (Hz)							
	63	125	250	500	1k	2k	4k	8k
Sound reduction index	5	6	8	12	19	19	18	17
Weighted sound reduction index (Rw)	16							
Static insertion loss	4	5	8	12	20	20	20	21
Regenerated sound power level at 1m/s face velocity	53	46	43	40	41	36	24	12
Regenerated sound power level at 2m/s face velocity	74	66	60	57	57	56	50	40

## Free Area and Height range

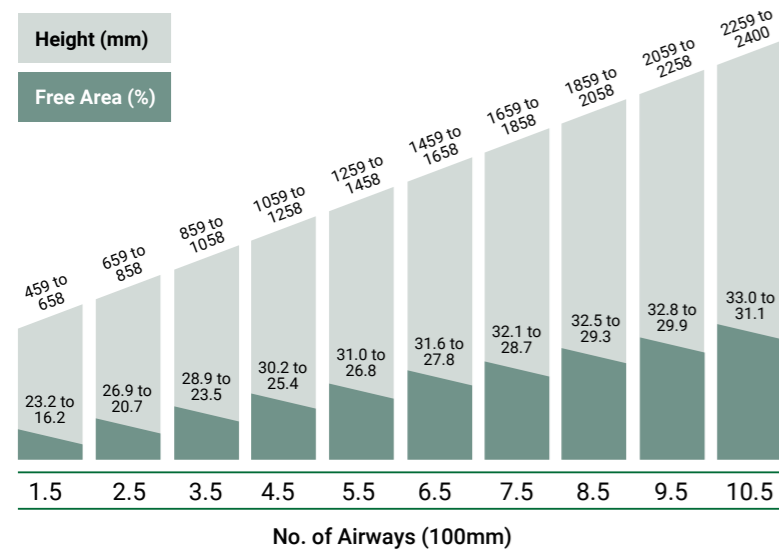

Free area and pressure drop shown is based on a 1150mm wide single piece louvre fitted with bird mesh and will vary slightly for different widths and larger heights. Pressure losses for Class A rated louvres and/or Insect mesh are available upon request.

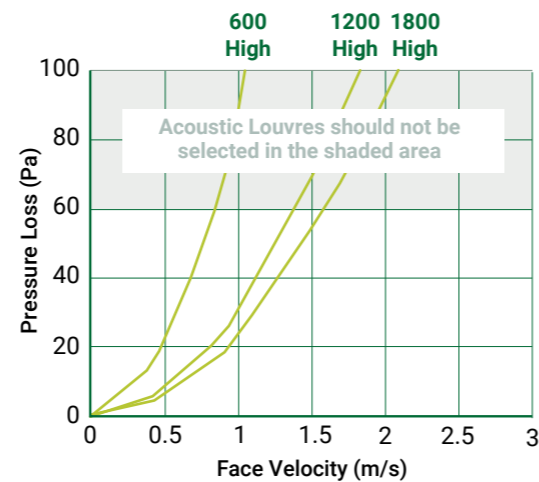

# CS600 Acoustic Louvre Technical Data



## Chevron Acoustic Louvre, Standard Performance Profile, 600mm Deep

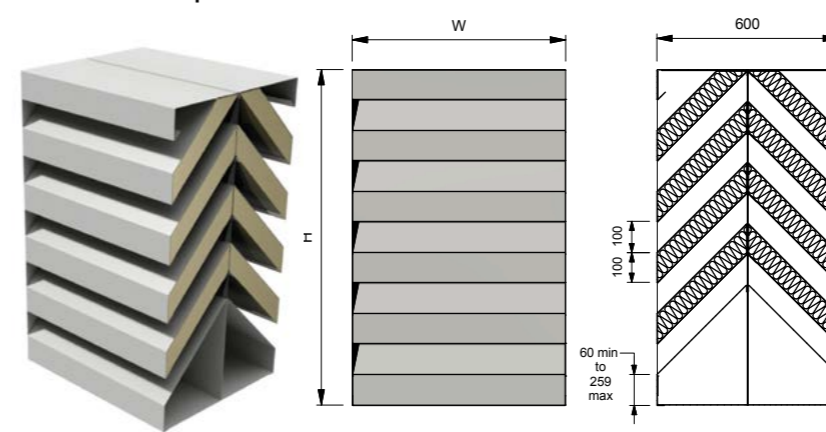

Typical weight 85kg/m<sup>2</sup>

Generally louvres above 50kg will be supplied in modules for assembly on site. Joining brackets and fixings will be provided for assembly.

Installation services, support steelwork, flashings, fixings to the structure and mastic will not be provided unless stated.

Refer to the Acoustic Louvre Schedule and Product Code Definitions for the size and specification of each Acoustic Louvre.

A minimum of 10mm clearance should be allowed between the structure and the Acoustic Louvre sizes shown.

Site constraints may make the installation of the Chevron style product impractical. Please contact Caice to discuss your requirements before selecting.

## Performance

Acoustic Data	dB in each Octave Band Centre Frequency (Hz)							
	63	125	250	500	1k	2k	4k	8k
Sound reduction index	7	8	13	23	37	33	29	29
Weighted sound reduction index (Rw)	25							
Static insertion loss	6	8	13	23	38	32	32	32
Regenerated sound power level at 1m/s face velocity	54	46	37	32	28	24	15	12
Regenerated sound power level at 2m/s face velocity	71	66	57	50	47	46	41	30

## Free Area and Height range

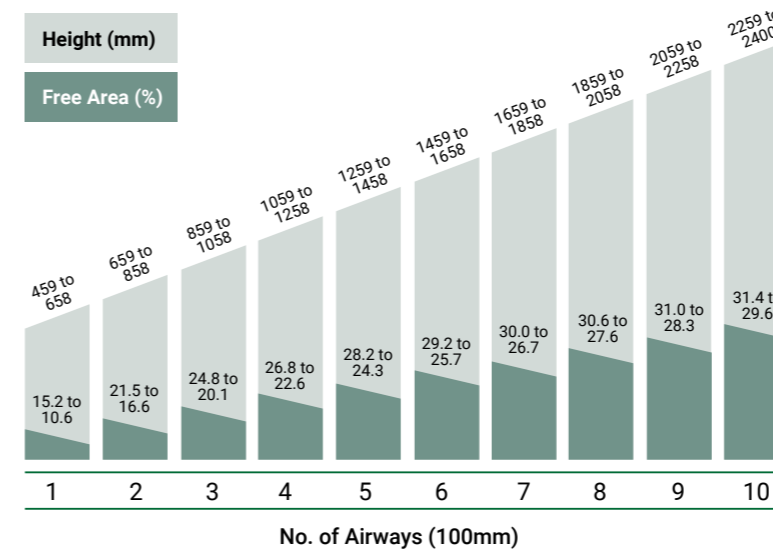

Free area and pressure drop shown is based on a 1150mm wide single piece louvre fitted with bird mesh and will vary slightly for different widths and larger heights. Pressure losses for Class A rated louvres and/or Insect mesh are available upon request.

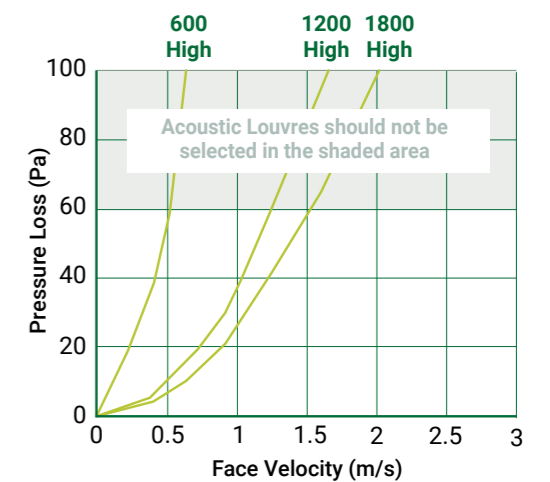

# DS150 Dummy Acoustic Louvre Technical Data



## Single Bank Dummy Acoustic Louvre, Standard Performance Profile, 150mm Deep

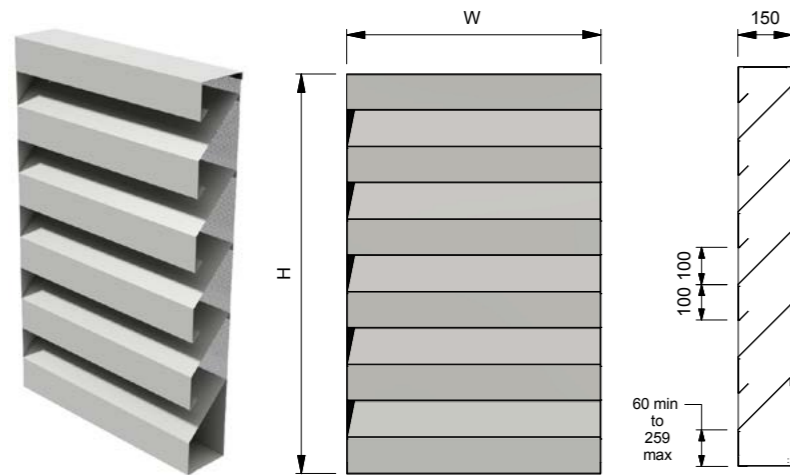

Typical weight 17kg/m<sup>2</sup>

Generally louvres above 50kg will be supplied in modules for assembly on site. Joining brackets and fixings will be provided for assembly.

Installation services, support steelwork, flashings, fixings to the structure and mastic will not be provided unless stated.

Refer to the Acoustic Louvre Schedule and Product Code Definitions for the size and specification of each Acoustic Louvre.

A minimum of 10mm clearance should be allowed between the structure and the Acoustic Louvre sizes shown.

# DH150 Dummy Acoustic Louvre Technical Data



## Single Bank Dummy Acoustic Louvre, Higher Performance Profile, 150mm Deep

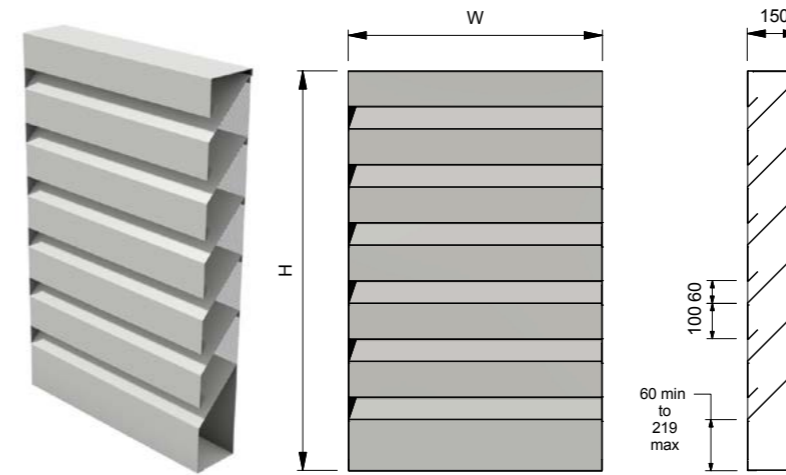

Typical weight 25kg/m<sup>2</sup>

Generally louvres above 50kg will be supplied in modules for assembly on site. Joining brackets and fixings will be provided for assembly.

Installation services, support steelwork, flashings, fixings to the structure and mastic will not be provided unless stated.

Refer to the Acoustic Louvre Schedule and Product Code Definitions for the size and specification of each Acoustic Louvre.

A minimum of 10mm clearance should be allowed between the structure and the Acoustic Louvre sizes shown.

## Performance

Acoustic Data	dB in each Octave Band Centre Frequency (Hz)							
	63	125	250	500	1k	2k	4k	8k
Regenerated sound power level at 1m/s face velocity	48	41	34	35	30	22	13	12
Regenerated sound power level at 2m/s face velocity	66	58	51	51	50	47	41	28

## Performance

Acoustic Data	dB in each Octave Band Centre Frequency (Hz)							
	63	125	250	500	1k	2k	4k	8k
Regenerated sound power level at 1m/s face velocity	53	47	38	36	33	29	18	12
Regenerated sound power level at 2m/s face velocity	70	65	58	53	51	51	45	35

## Free Area and Height range

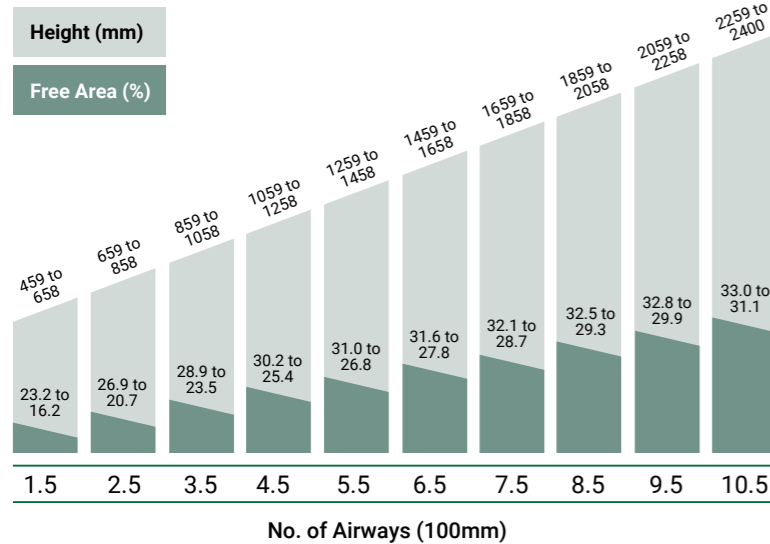

Free area and pressure drop shown is based on a 1150mm wide single piece louvre fitted with bird mesh and will vary slightly for different widths and larger heights. Pressure losses for Class A rated louvres and/or Insect mesh are available upon request.

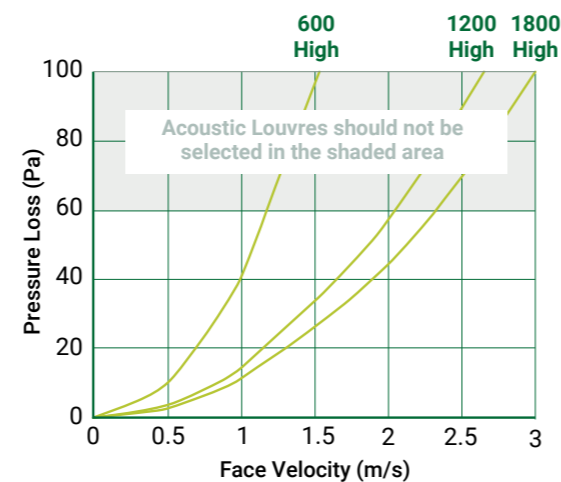

## Free Area and Height range

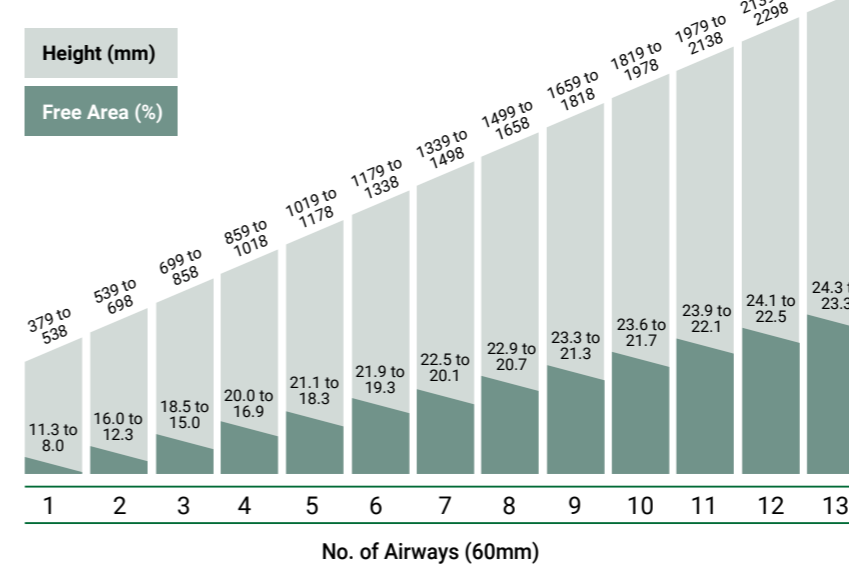

Free area and pressure drop shown is based on a 1150mm wide single piece louvre fitted with bird mesh and will vary slightly for different widths and larger heights. Pressure losses for Class A rated louvres and/or Insect mesh are available upon request.

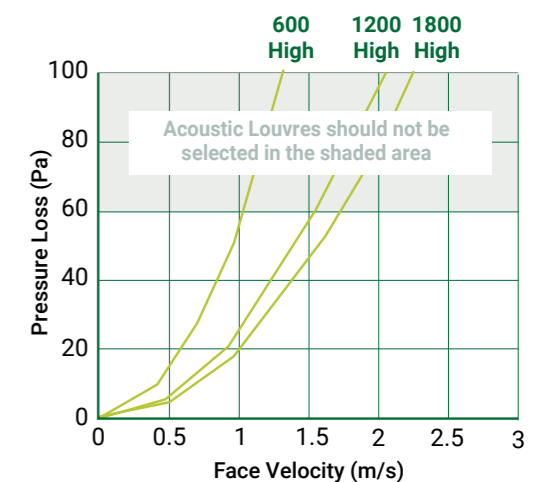

# Specifying the Acoustic Louvre system

---

## Acoustic Louvre specification

We're here to help and can provide a detailed Acoustic Louvre specification for inclusion within the overall specification for your project. This is also available in a short form NBS Specification format if required.

t: +44 (0)118 918 6470

f: +44 (0)118 918 6480

enquiries@caice.co.uk

caice.co.uk



### Head office & registered office

Riverside House, Unit 3, Winnersh Fields  
Wokingham, Berkshire  
RG41 5QS

### Northern region sales office

Ground Floor, Units C - E  
Toller Court, Short Bank Road  
Skipton, North Yorkshire  
BD23 2HG

### South west region sales office

Bank House, Bath Road  
Chippenham, Wiltshire  
SN15 2SA



\* Gold Award in the prestigious Command Wessex BEST Awards 2001, with a "World Class" benchmarked score against thousands of other similar businesses throughout the UK and Europe.